	Standard No.	MODEL	NAME	REV.	PAGE
	PL-LCDM4000-004	LCDM-4000	Service Manual	1.05	1 of 24

Service Manual

MODEL : LCDM-4000
REV. : 1.05
DATE : 2009. 12. 3

 **PULOON Technology Inc.**

	Standard No.	MODEL	NAME	REV.	PAGE
	PL-LCDM4000-004	LCDM-4000	Service Manual	1.05	2 of 24

Revision History

Ver.	Date	Contents		Editor
		Cause of Revision	Details	
1.01	2005.05.01	Released by Puloon Lab.		
1.02	2005.11.23	Rated consuming current		
1.03	2007. 02. 05	Error code description method changed		
1.04	2007. 02. 05	PWA(Control Board) Connector Description Added		
1.05	2009.12. 3	Error Code Added and Descriptions are corrected	<p>Ch. 4 Error Codes Added (0x29, 0x40, 0x41, 0x42, 0x43)</p> <p>Ch 4 Error Codes Descriptions are described in details. (0x07~0x0A)</p>	H.H.So

	Standard No.	MODEL	NAME	REV.	PAGE
	PL-LCDM4000-004	LCDM-4000	Service Manual	1.05	3 of 24

Contents

1	Preview	4
2	Basic Specification and Structure	5
2.1	Basic Specification of LCDM	5
2.2	Cash Cassette Assembly.....	5
2.2.1	Note Size Available	7
2.2.2	Cash Cassette Door.....	7
2.2.3	Cash Cassette Body	7
2.2.4	Cash Cassette Base	7
2.2.5	Bill-End Detection	7
2.3	Basic Structure of Feed Module	8
2.3.1	Banknote Separation Mechanism(One-way Roller).....	9
2.3.2	Thickness Detection	10
2.3.3	Diverting Mechanism	11
2.3.4	Feeding Mechanism.....	12
2.3.5	Sensor Assignment.....	14
2.3.6	Power Transmissition.....	16
3	H/W Configuration.....	18
4	Error Codes and Maintenance.....	19
4.1	Error Codes and descriptions	19
4.2	Maintenance for Error Codes	21
4.2.1	Pick-up Error (Code: 0x21)	21
4.2.2	Path Jam (Codes: 0x22, 0x23, 0x24, 0x25).....	22
4.2.3	Diverting Mechanism Failure (Codes: 0x26, 0x42).....	22
4.2.4	Motor Stop (Code: 0x43).....	23
4.2.5	Over-reject (Code: 0x2D).....	23
4.2.6	Sensor Error on the Path (Code: 0x2B, 0x40, 0x41)	23
4.2.7	Cassette Error (Code: 0x44).....	23
4.2.8	Reject Tray Error (Code: 0x46).....	24

	Standard No.	MODEL	NAME	REV.	PAGE
	PL-LCDM4000-004	LCDM-4000	Service Manual	1.05	4 of 24

1 Preview

The document is the technical manual of service, repair and maintenance of LCDM-4000. LCDM-4000 consists of Feed Module, Cash Cassette, Reject Tray and Main Controller.

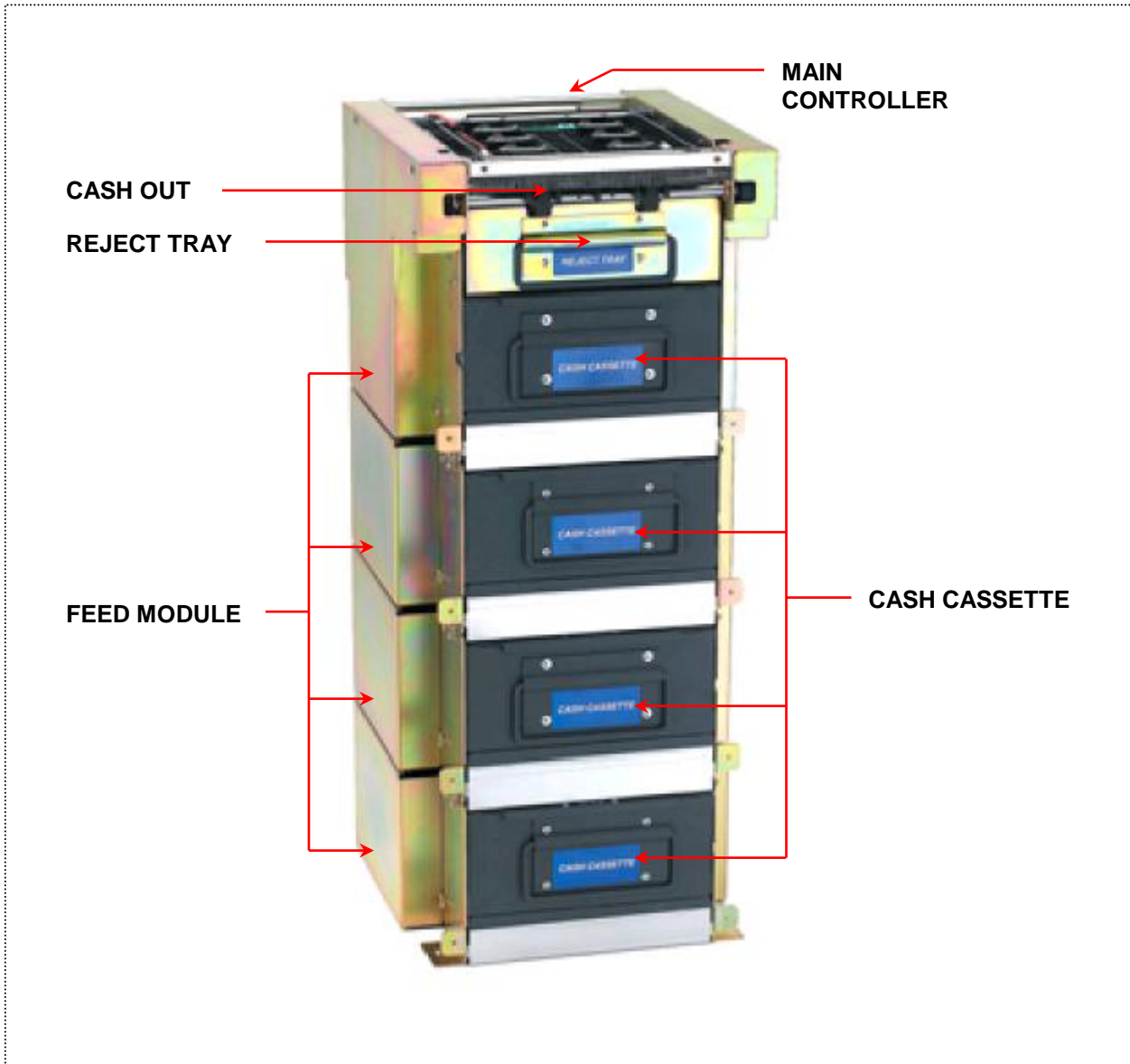

	Standard No.	MODEL	NAME	REV.	PAGE
	PL-LCDM4000-004	LCDM-4000	Service Manual	1.05	5 of 24

2 Basic Specification and Structure

2.1 Basic Specification of LCDM

No.	Item	Specification
1	Denomination	4 Denomination
2	Cassette Capacity	approx. 1,000 notes (123mm) per Cassette
3	Dispensing Speed	4 notes/sec
4	Usable Note Size	Width: 100 ~ 162mm / Height: 62 ~ 78mm
5	Double Feeding Detection	Mechanical Type
6	Reject Capacity	About 30 notes
7	Access Type	Front Access Type
8	Dimension (unit: mm)	310.2(D) x 618(H) x 270.5(W)
9	Near-end detection	About 10 ~ 30 Notes
10	Interface	RS 232C
11	Rated Voltage	DC24V±10%
12	Rated Consuming Current	Load current, continuous MIN - 0.16A MAX - 4.1A Load current, peak Max - 5.4A
13	Operation Temperature	+ 5 °C ~ +40 °C

2.2 Cash Cassette Assembly

Cash cassette assembly consists of Cassette Door , Cassette Body and Cassette Base and the capacity of each cash cassette assembly is about 1,000 notes (123 mm).

	Standard No.	MODEL	NAME	REV.	PAGE
	PL-LCDM4000-004	LCDM-4000	Service Manual	1.05	6 of 24

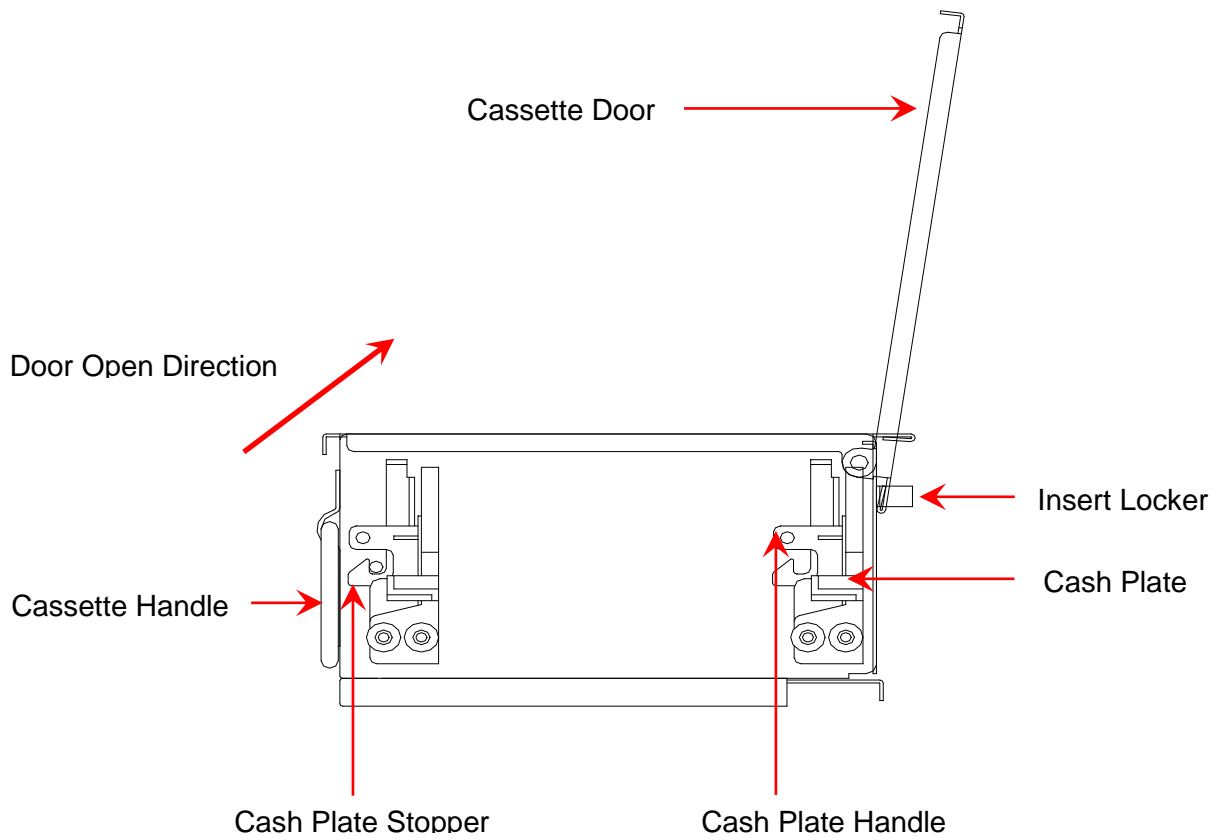

(210mm × 297mm)

	Standard No.	MODEL	NAME	REV.	PAGE
	PL-LCDM4000-004	LCDM-4000	Service Manual	1.05	7 of 24

2.2.1 Note Size Available

Minimum		Maximum	
Height	Width	Height	Width
62mm	100mm	76mm	162mm

2.2.2 Cash Cassette Door

Cash cassette door has no security and the door of cash cassette is closed with the magnetic force. On opening door, the door can be opened by pushing to label direction.

2.2.3 Cash Cassette Body

Cash cassette body consists of Frame, Pusher and Pusher Stopper. Pusher is guiding the banknotes onto the pick-up roller with spring force aligning with both sides. Pusher Stopper stops the pusher at the end of locking position in order to load the banknotes and releases the pusher on unlocking by pushing onto its top.

2.2.4 Cash Cassette Base

Cash Cassette Base is attached to the cash cassette and controls the flow of banknote from the box bottom to the main body of cash dispenser.

2.2.5 Bill-End Detection

Bill-end Detection is decided by setting dip switches on the electronic board. (#1 of switches : Off) In case #1 is On, the banknotes can be dispensed and stopped until 30 banknotes remain with the message "Bill-end" to the host. If the switch is set to Off, all the banknotes would be dispensed in the end and during the transaction, the warning signal, "Bill-end" will be sent to the host.

Detection sensor and bracket are installed in the main body of cash dispenser and the counter area is prepared in the front of cash cassette.

	Standard No.	MODEL	NAME	REV.	PAGE
	PL-LCDM4000-004	LCDM-4000	Service Manual	1.05	8 of 24

2.3 Basic Structure of Feed Module

Feed Module consists of Banknote Separation Mechanism(One-way Roller), Thickness Detection(Double Detection Mechanism), Divertering Mechanism and Feeding Mechanism.

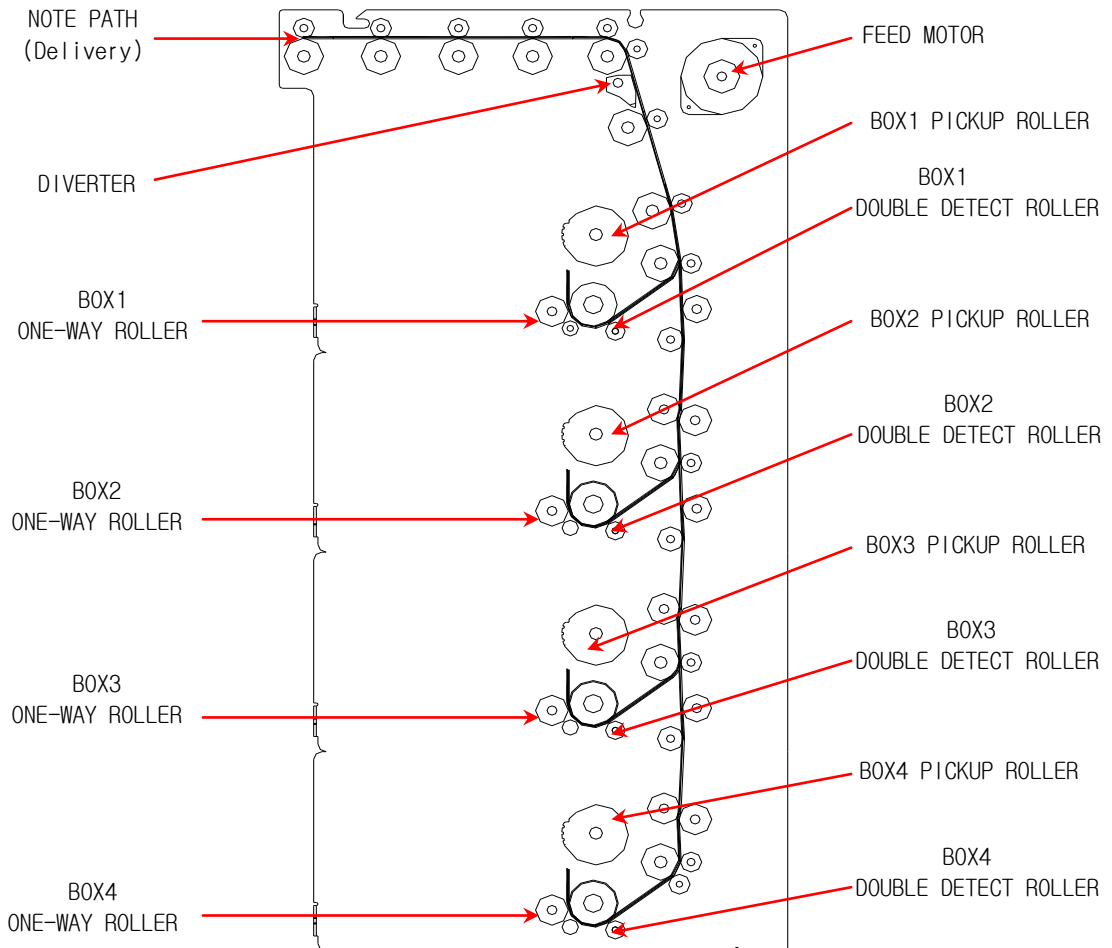

	Standard No.	MODEL	NAME	REV.	PAGE
	PL-LCDM4000-004	LCDM-4000	Service Manual	1.05	9 of 24

2.3.1 Banknote Separation Mechanism(One-way Roller)

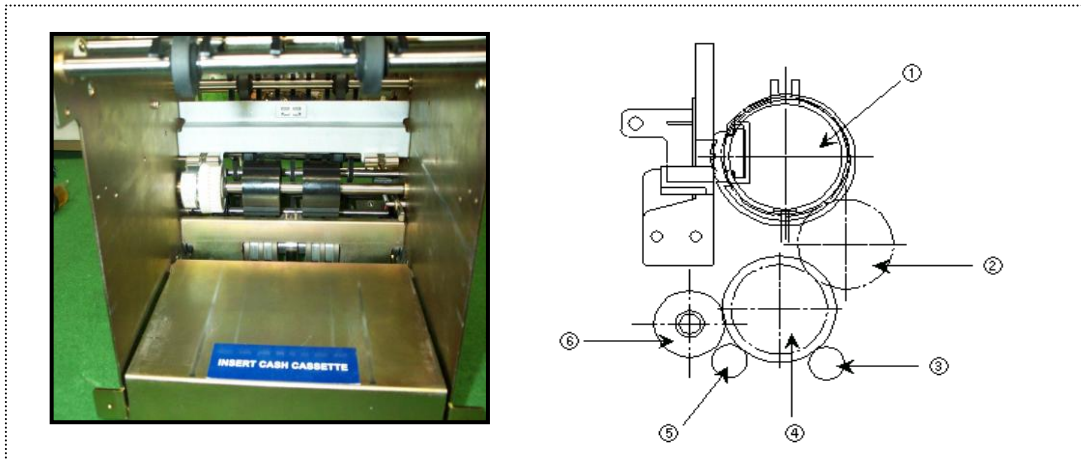

< Configuration of Banknote Separation Mechanism >

(1) Features

- Banknote separation by friction roller feeding
- Separation Spded : 4 notes per second
- Power transmission by clutch

(2) Description

NO	Item	Function
①	SHAFT PICK-UP ROLLER ASS'Y	To pick up banknote from the Cash Cassette
②	SHAFT SPACE CONNECTION ASS'Y	To transmit the power to ① and ④
③	ROLLER IDLE	Idle rollers to move the banknote
④	SHAFT FEED ROLLER ASS'Y	To feed the picked banknotes
⑤	ROLLER IDLE	Idle rollers to move the banknote
⑥	SHAFT ONEWAY ROLLER ASS'Y	To separate the picked notes

	Standard No.	MODEL	NAME	REV.	PAGE
	PL-LCDM4000-004	LCDM-4000	Service Manual	1.05	10 of 24

2.3.2 Thickness Detection

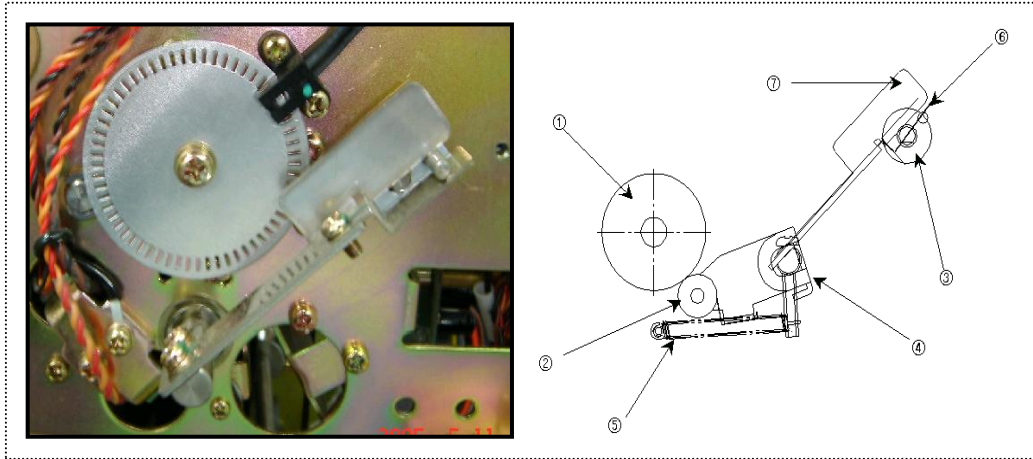

< Configuration of Thickness Detection >

(1) Features

- Thickness detection by mechanical amplification of rotational variance

(2) Description

NO	Item	Function
①	SHAFT FEED ROLLER ASS'Y	Datum roller for the measurement of thickness of banknotes
②	BEARING R 1240	Counter-roller to Datum roller to measure the thickness of banknotes
③	RVDT (LP06M3R)	Sensing element to measure the rotational variance amplified by mechanical mechanism on feeding banknotes
④	ARM D/D HINGE	Mechanism as a kind of lever to amplify the thickness variance
⑤	SPRING RVDT TENSION	To push the detect roller properly
⑥	PLATE D/D SENSOR	Stopper to prevent from overturning RVDT
⑦	LEVER D/D HINGE	To transmit the rotational variance of ④ to RVDT

	Standard No.	MODEL	NAME	REV.	PAGE
	PL-LCDM4000-004	LCDM-4000	Service Manual	1.05	11 of 24

2.3.3 Diverting Mechanism

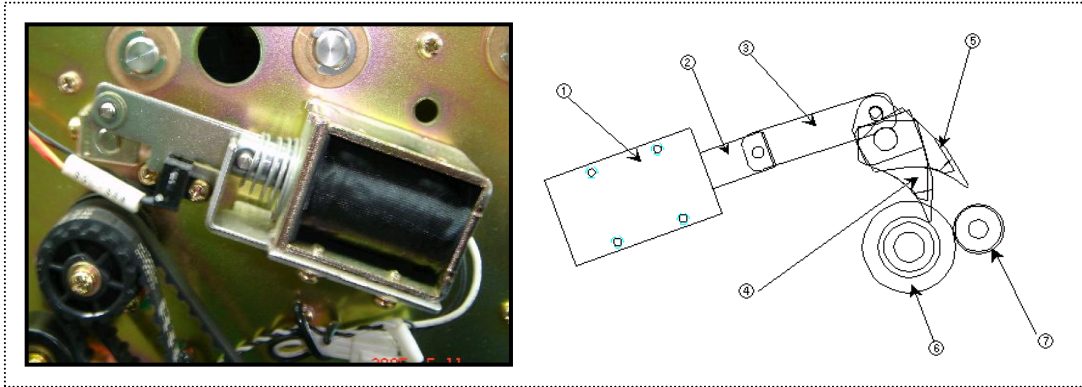

< Configuration of Diverting Mechanism >

(1) Features

- Diverting mechanism by Solenoid

(2) Description

NO	Item	Function
①	SOLENOID 1040 JUWON	Solenoid to operate diverter
②	SOLENOID PLUNGER	Plunger (Pull operation type)
③	LINK SOLENOID STAMP	To transmit the SOLENOID operation
④	SHAFT DIVERTER ASS'Y (Normal Status)	Divertering assembly to operate eject action or reject action
⑤	SHAFT DIVERTER ASS'Y (Reject Situation)	
⑥	SHAFT ASS'Y CASH FEED 3	Feeding rollers
⑦	ROLLER ASS'Y IDLE 13	Idle rollers

	Standard No.	MODEL	NAME	REV.	PAGE
	PL-LCDM4000-004	LCDM-4000	Service Manual	1.05	12 of 24

2.3.4 Feeding Mechanism

(1) Features

- Feeding mechanism has two kinds of rollers, one is for feeding and the other is idle roller.
- Feeding guide is made from mold and enables to clear jam with ease.
- Upper feeding guide is open type to increase the maintenance efficiency.

(2) Configuration

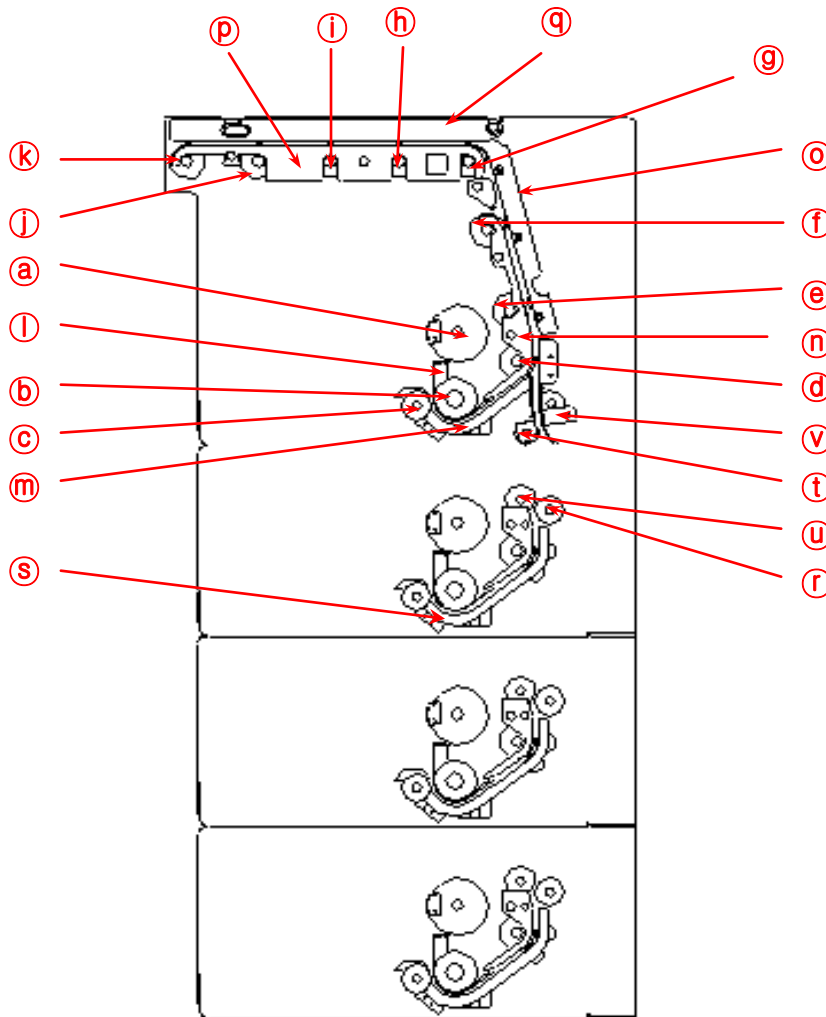

	Standard No.	MODEL	NAME	REV.	PAGE
	PL-LCDM4000-004	LCDM-4000	Service Manual	1.05	13 of 24

- Name of each part

NO	Item
(a)	SHAFT ASS'Y PICK-UP ROLLER
(b)	SHAFT ASS'Y FEED ROLLER
(c)	SHAFT ASS'Y ONEWAY ROLLER
(d)	SHAFT ASS'Y CASH FEED 1
(e)	SHAFT ASS'Y CASH FEED 2
(f)	SHAFT ASS'Y CASH FEED 3
(g)	SHAFT ASS'Y CASH FEED 4
(h)	SHAFT ASS'Y CASH FEED 5
(i)	SHAFT ASS'Y CASH FEED 6
(j)	SHAFT ASS'Y CASH FEED 6
(k)	SHAFT ASS'Y CASH FEED 6
(l)	GUIDE CASH FEED 1
(m)	GUIDE CASH FEED 2 LCDM-2000 ASS'Y
(n)	GUIDE CASH FEED 3 ASS'Y
(o)	GUIDE CASH FEED 5 ASS'Y
(p)	GUIDE CASH FEED 6 ASS'Y
(q)	GUIDE CASH FEED 7 ASS'Y
(r)	SHAFT ASS'Y CASH FEED 8
(s)	GUIDE CASH FEED 2 ASS'Y
(t)	GUIDE PRESS 2 ASS'Y
(u)	SHAFT ASS'Y CASH FEED 7
(v)	GUIDE PRESS 1 ASS'Y

	Standard No.	MODEL	NAME	REV.	PAGE
	PL-LCDM4000-004	LCDM-4000	Service Manual	1.05	14 of 24

2.3.5 Sensor Assignment

LCDM-1000 has 11 pieces of sensors and each additional denomination needs 5 additional sensors. So for LCDM-4000, the maximum number of sensors 26 pieces of sensors.

(1) Sensor Layout Drawing

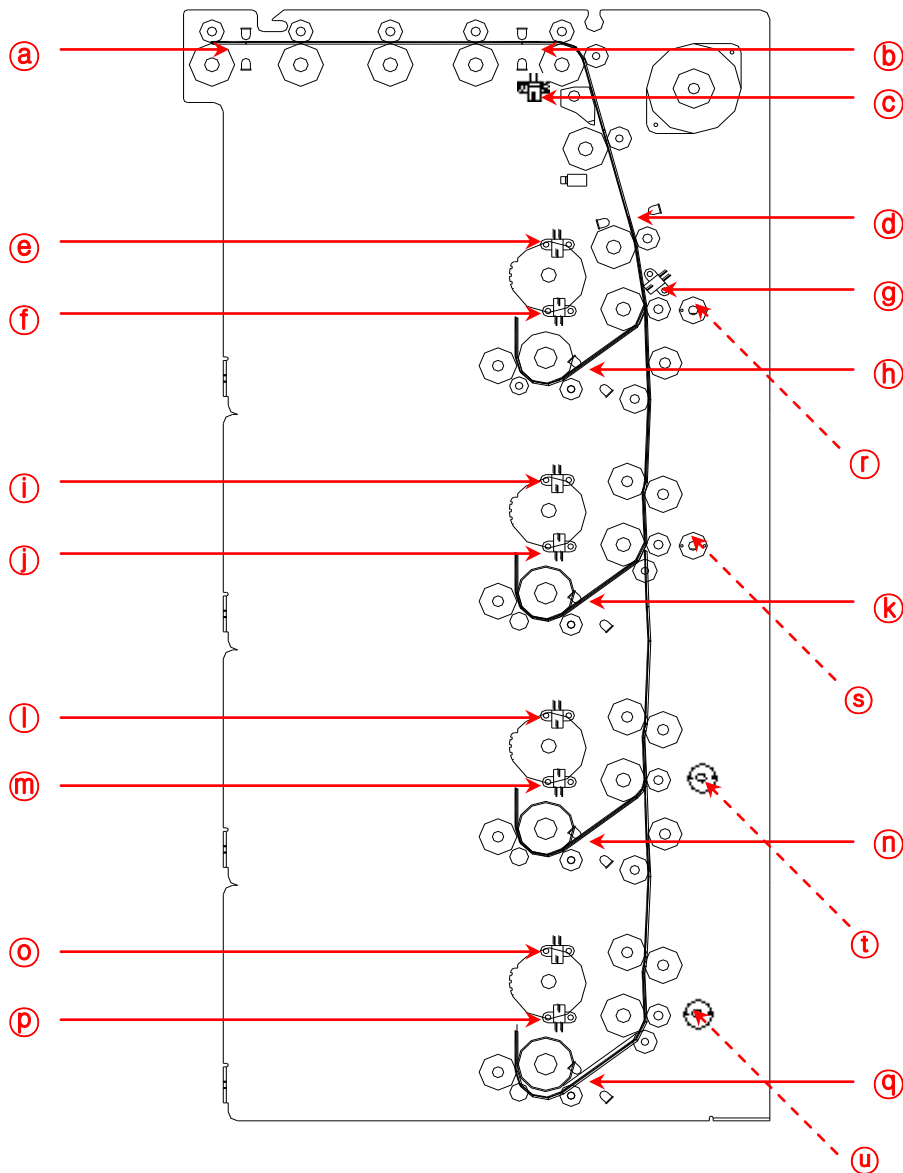

	Standard No.	MODEL	NAME	REV.	PAGE
	PL-LCDM4000-004	LCDM-4000	Service Manual	1.05	15 of 24

(2) Functional Description of Sensors

NO	Sensor Name	Function
Ⓐ	EXIT SENSOR	To count the dispensed notes
Ⓑ	EJT SENSOR	To count the passed notes through the diverting mechanism
Ⓒ	SOL SENSOR	To detect Diverter status.
Ⓓ	DIVL/DIVR SENSOR	To enable to operate diverter mechanism
Ⓔ	BOX1 BOX SENSOR	To check the existence of Cash Cassette 1
Ⓕ	BOX1 NEND SENSOR	To check the existence of the remaining notes inside Cash Cassette 1
Ⓖ	WHEEL SENSOR	To check the speed of motor
Ⓗ	BOX1 CHKL/CHKR SENSOR	To measure length, distance and skewness of the banknotes from Cash Cassette 1
Ⓘ	BOX2 BOX SENSOR	To check the existence of Cash Cassette 2
Ⓝ	BOX2 NEND SENSOR	To check the existence of the remaining notes inside Cash Cassette 2
Ⓚ	BOX2 CHKL/CHKR SENSOR	To measure length, distance and skewness of the banknotes from Cash Cassette 2
Ⓛ	BOX3 BOX SENSOR	To check the existence of Cash Cassette 3
Ⓜ	BOX3 NEND SENSOR	To check the existence of the remaining notes inside Cash Cassette 3
Ⓝ	BOX3 CHKL/CHKR SENSOR	To measure length, distance and skewness of the banknotes from Cash Cassette 3
Ⓞ	BOX4 BOX SENSOR	To check the existence of Cash Cassette 4
Ⓟ	BOX4 NEND SENSOR	To check the existence of the remaining notes inside Cash Cassette 4
Ⓠ	BOX4 CHKL/CHKR SENSOR	To measure length, distance and skewness of the banknotes from Cash Cassette 4
Ⓡ	BOX1 RVDT SENSOR	To measure the thickness of banknotes from Cash Cassette 1
Ⓢ	BOX2 RVDT SENSOR	To measure the thickness of banknotes from Cash Cassette 2
Ⓣ	BOX3 RVDT SENSOR	To measure the thickness of banknotes from Cash Cassette 3
Ⓤ	BOX4 RVDT SENSOR	To measure the thickness of banknotes from Cash Cassette 4

	Standard No.	MODEL	NAME	REV.	PAGE
	PL-LCDM4000-004	LCDM-4000	Service Manual	1.05	16 of 24

2.3.6 Power Transmission

(1) Features

LCDM series use one motor to operate all the series and control the power transmission by clutches.

(2) Description of power transmission

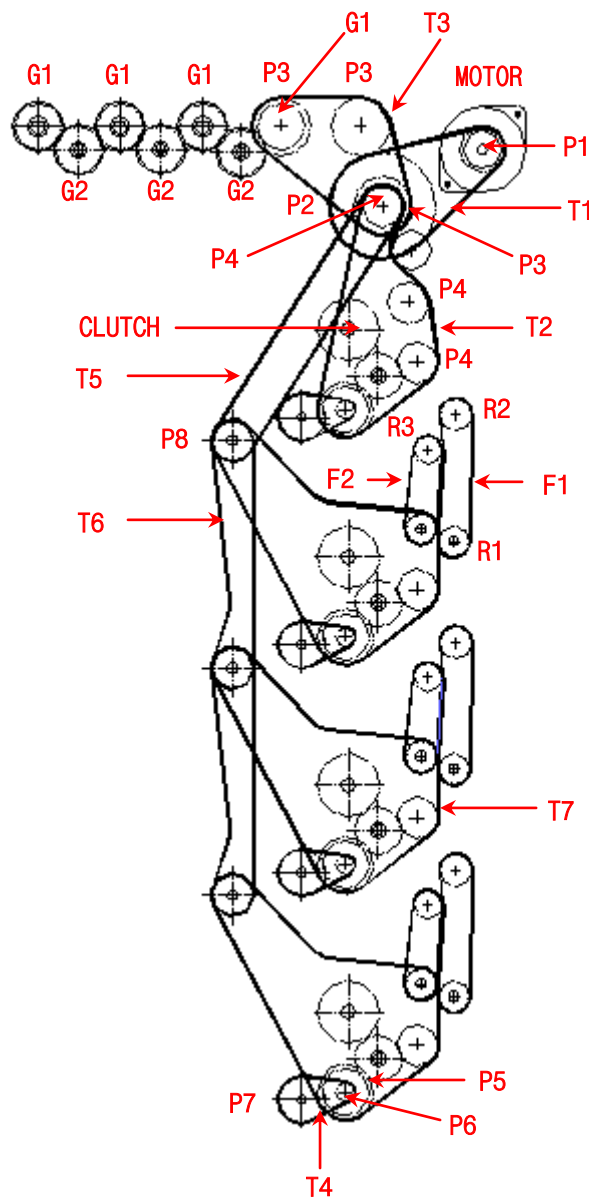

<Configuration of Power Transmission >

	Standard No.	MODEL	NAME	REV.	PAGE
	PL-LCDM4000-004	LCDM-4000	Service Manual	1.05	17 of 24

- Name of each part

NO	Item	Function
G1	GEAR FEED (Z:27, M:1)	Gear to transmit the motor torque with proper reduction ratio
G2	GEAR DFDM DRIVE (Z:27, M:1)	Idle gear to transmit the motor torque from the GEAR FEED
P1	PULLY MOTOR (XL16, ϕ 6)	Pulley on the motor
P2	PULLY CASH FEED1	Pulley to reduce the speed
P3	PULLY CASH FEED2	Pulley to drive feeding rollers
P4	PULLY FEED (XL15, ϕ 8)	Pulley to drive feeding rollers
P5	PULLY FEED (XL20, ϕ 8)	Pulley to drive feeding rollers
P6	PULLY DRV MXL17	Pulley to reduce the speed of Oneway rollers
P7	PULLY REVERSE (MXL42, ϕ 8)	Pulley to reduce the speed of Oneway rollers
T1	BELT TIMING 108XL (W = 6.4)	Belt between Motor and reduction pulley
T2	BELT TIMING 140XL (W = 6.4)	Belt to drive feeding rollers
T3	BELT TIMING 108XL (W = 6.4)	Belt to drive feeding rollers
T4	BELT TIMING 56MXL (W = 3.2)	Belt to reduce the speed of Oneway rollers
T5	BELT TIMING 156XL (W = 6.4)	Belt to drive PULLY IDLE
T6	BELT TIMING 134XL (W = 7.0)	Belt to drive PULLY IDLE
T7	BELT TIMIG 166XL (W = 6.4)	Belt to drive Feeding rollers
F1	BELT FEEDING S197 (W=10)	Belt to drive Feeding rollers
F2	BELT FEEDING S140 (W=10)	Belt to drive Feeding rollers
R1	ROLLER FEED CROWN (ϕ 18)	Driving rollers
R2	ROLLER IDLE CROWN (ϕ 18)	Feeding Rollers
R3	ROLLER IDLE CROWN (ϕ 16)	Feeding Rollers

	Standard No.	MODEL	NAME	REV.	PAGE
	PL-LCDM4000-004	LCDM-4000	Service Manual	1.05	18 of 24

3 H/W Configuration

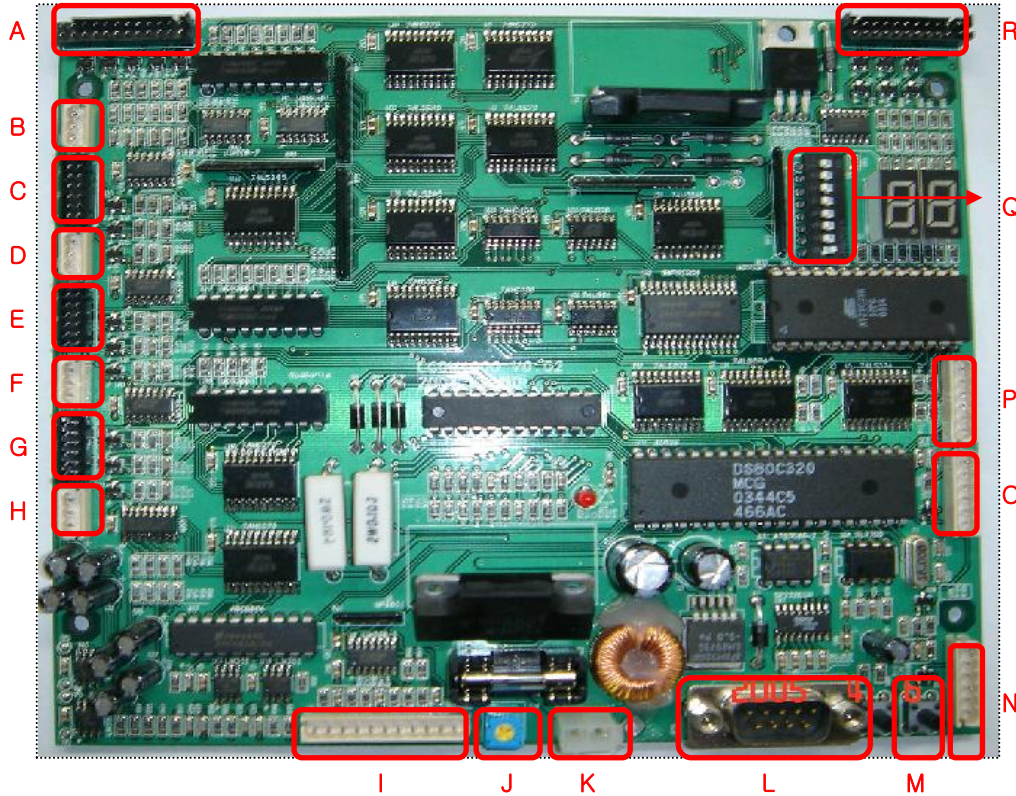

Remark	Connector	Connected Elements
A	J4	1) BOX1 CHK_R & NEAREND & CASSETTE Sensor 2) DIV_R & WHEEL Sensor 3) EJT & EXIT Emission Sensor
B	JP2	BOX1 RVDT Sensor
C	J6	BOX2 CHK_R & NEAREND & CASSETTE Sensor
D	JP4	BOX2 RVDT Sensor
E	J8	BOX3 CHK_R & NEAREND & CASSETTE Sensor
F	JP1	BOX3 RVDT Sensor
G	J10	BOX4 CHK_R & NEAREND & CASSETTE Sensor
H	JP3	BOX4 RVDT Sensor
I	J2	Motor
J	R30	Variable Resistance to Control Motor Speed
K	J1	24V DC POWER
L	JP5	RS232 Communication Port (9 Pin D-Sub)
M	S4	Hardware Reset Switch
N	J9	BOX4 : CHK_L Sensor & CLUTCH
O	J7	BOX3 CHK_L Sensor & CLUTCH
P	J5	BOX2 CHK_L Sensor & CLUTCH
Q	SW1	DIP SWITCH for Setting Mode
R	J3	BOX1 CHK_L Sensor & CLUTCH

(210mm × 297mm)

	Standard No.	MODEL	NAME	REV.	PAGE
	PL-LCDM4000-004	LCDM-4000	Service Manual	1.05	19 of 24

4 Error Codes and Maintenance

4.1 Error Codes and descriptions

The error code in response can be calculated by the below code value adding to 0x20.

Code	Description
0x01	Bill Pick Up Error
0x02	Jam on the path between CHK Sensor and DVT Sensor
0x03	Jam on the path between DVT Sensor and EJT Sensor
0x04	Jam on the path between EJT Sensor and EXIT Sensor
0x05	A note Staying in EXIT Sensor
0x06	Ejecting the note suspected as rejected
0x07	Note count mis-match on eject sensor due to unexpected reason
0x08	The note which should be rejected is passed on eject sensor
0x09	The media length on eject sensor is too long due to slip or abnormal reason.
0x0A	The media length on exit sensor is too long due to slip or abnormal reason.
0x0B	Detecting notes on the path before start of pick-up
0x0C	Dispensing too many notes for one transaction (Default limit: 100 notes including the rejected)
0x0D	Rejecting too many notes for one transaction (Default limit: 10 notes)
0x0E	Abnormal termination during purge operation
0x20	Detecting sensor trouble or abnormal material before start
0x21	Detecting sensor trouble or abnormal material before start
0x22	Detecting trouble of solenoid operation before dispense
0x23	Detecting trouble in motor or slit sensor before dispense
0x24	Detecting no cassette requested to dispense bills
0x25	Detecting NEAREND status in the cassette requested to dispense (When NEAREND detection mode is turned on)
0x26	Detecting no reject tray before start or for operation
0x29	The number of the dispensed is more than that of the requested.
0x30	Recognizing abnormal command
0x31	Recognizing abnormal parameter on the command
0x32	Not to Operate VERIFY Command after Downloading and Reset
0x33	Program area writing Failure
0x34	Verify Failure
0x35	EEPROM Write Failure
0x36	Check Sum Error on Writing EEPROM

	Standard No.	MODEL	NAME	REV.	PAGE
	PL-LCDM4000-004	LCDM-4000	Service Manual	1.05	20 of 24

0x40	During dispensing from the 2 nd , 3 rd or Bottom Cassette, the banknote coming from the Top Cassette is detected.
0x41	During dispensing from the 1 st , 3 rd or Bottom Cassette, the banknote coming from the 2 nd Cassette is detected.
0x42	During dispensing from the 1 st , 2 nd or Bottom Cassette, the banknote coming from the 3 rd Cassette is detected.
0x43	During dispensing from the 1 st , 2 nd or 3 rd Cassette, the banknote coming from the 4 th Cassette is detected.

	Standard No.	MODEL	NAME	REV.	PAGE
	PL-LCDM4000-004	LCDM-4000	Service Manual	1.05	21 of 24

4.2 Maintenance for Error Codes

4.2.1 Pick-up Error (Code: 0x01)

- 1) Checking the loading status of the banknotes inside Cash Cassette

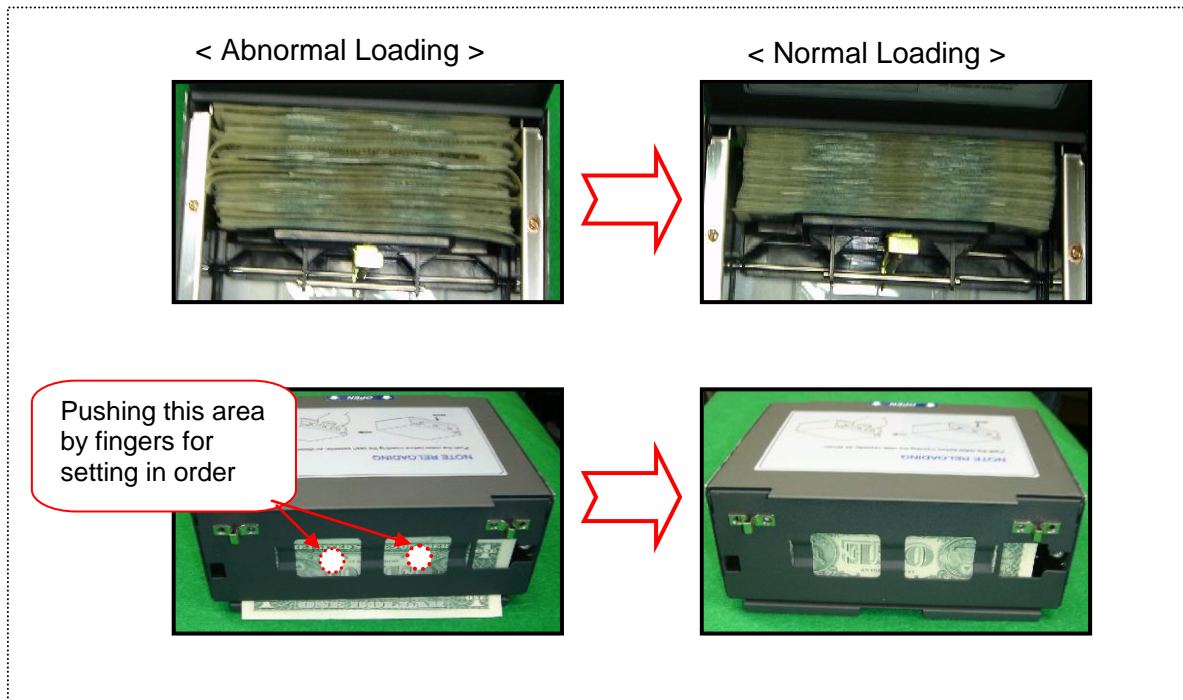

- 2) Checking the loading of Cash Cassette onto the main body

: Push the cash cassettes to the direction to the main body until the end line of cash cassette is aligned with the edge lind of main body.



	Standard No.	MODEL	NAME	REV.	PAGE
	PL-LCDM4000-004	LCDM-4000	Service Manual	1.05	22 of 24

3) Checking the mobility of pusher inside Cash Cassette

: The pusher is to be moved freely keeping spring force except locking position.



4) Checking the remaining banknotes in the Cash Cassette

: In case of setting of dip switch #1 Off, all the notes are dispensed and the finally no banknote remain. So the pick up error sign would be displayed because of lack of banknotes in the Cash Cassette.

5) Checking if Clutch is normal or failed.

6) Checking the failure of electronic board

4.2.2 Path Jam (Codes: 0x02, 0x03, 0x04, 0x05)

1) Checking the assembly status related to the feeding path

2) Checking status of sensors (Checking if it is normal detection for jam)

3) Clearing dust or unexpected dummy on the path

: Rotating know, the path should be cleared. Sometimes, test notes had better be put into the path in order to clear all the path.

4.2.3 Diverting Mechanism Failure (Codes: 0x06, 0x22)

1) Checking Solenoid Sensor

2) Checking the Status of Solenoid

3) Checking the failure of electronic board

	Standard No.	MODEL	NAME	REV.	PAGE
	PL-LCDM4000-004	LCDM-4000	Service Manual	1.05	23 of 24

4.2.4 Motor Stop (Code: 0x23)

- 1) Checking dust or unexpected material on the path
: By rotating knob, the remaining banknotes should be cleared of the path.
- 2) Checking if Wheel Sensor is operating
: Checking wheel sensor status and cables
- 3) Checking the failure of electronic board

4.2.5 Over-reject (Code: 0x0D)

- 1) Checking the sensor of CHK SENSOR
: Left and Right sided sensors should be checked.
- 2) Checking assembly status of RVDT mechanism

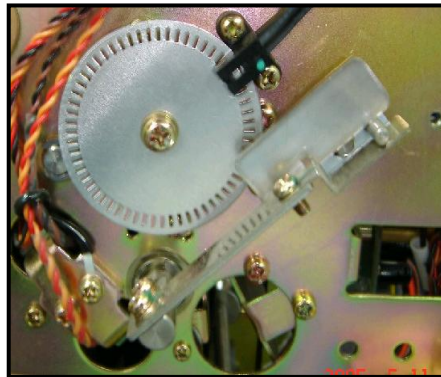

- 3) Checking the setting process of Length and RVDT
: It had better refer to the TEST Manual.
- 4) Checking the failure of electronic board

4.2.6 Sensor Error on the Path (Code: 0x0B, 0x20, 0x21)

- 1) Checking Each Sensor, Sensor Board and Cable Status
- 2) Checking the remaining banknotes on the path
: By rotating knob, the remaining banknotes should be cleared of the path.

4.2.7 Cassette Error (Code: 0x24)

- 1) Checking the Cash Cassette on the right position
- 2) Checking the sensor to detect the Cash Cassette

	Standard No.	MODEL	NAME	REV.	PAGE
	PL-LCDM4000-004	LCDM-4000	Service Manual	1.05	24 of 24

4.2.8 Reject Tray Error (Code: 0x26)

- 1) Checking the right position of reject tray
- 2) Checking the limit switch of main body to detect the Reject Tray
- 3) Checking the failure of electronic board