	DOC NO	MODEL	NAME	REV.	PAGE
	PL-ECDM0400-004	ECDM-400	Service Manual	1.01	1 of 65

Service Manual

MODEL : ECDM-400
REV. : 1.0
DATE : 2006. 12. 4



PULOON Technology Inc.

	DOC NO	MODEL	NAME	REV.	PAGE
	PL-ECDM0400-004	ECDM-400	Service Manual	1.01	2 of 65

Revision History

Ver.	DATE	Item		Name
		Title	Details	
1.00	2006.12. 4	First Released		H. J. KIM
1.01	2007. 8. 17	Correction of Power Spec	Conformed to Description on Product Spec Manual	W.H.PARK

	DOC NO	MODEL	NAME	REV.	PAGE
	PL-ECDM0400-004	ECDM-400	Service Manual	1.01	3 of 65

Contents

1	Preview	5
2	Basic Specification and Structure	5
2.1	Basic Specification	5
2.2	Structure	6
3	Main Mechanism Configuration	7
3.1	UNIT ECDM-400 MECHA	7
3.1.1	Double Notes Detection Mechanism	7
3.1.2	Diverting Mechanism	8
3.1.3	Feeding Part	9
3.2	UNIT CASH CASSETTE	12
3.2.1	Appearance	12
3.2.2	Configuration	13
3.3	UNIT REJECT CASSETTE	14
3.3.1	Appearance	14
3.3.2	Configuration	14
3.4	Sensor Assignment	15
3.5	Power Transmission	17
4	H/W Configuration	19
4.1	Main Board	19
4.1.1	Specification	19
4.1.2	Block Diagram	20
4.1.3	Layout of Main Board	20
4.2	Sensor Board	21
4.2.1	Sensor Circuit	21
4.2.2	Sensor PWA	23
4.3	Type Selection Board	24
4.3.1	Type Selection Circuit	24
4.3.2	Type Selection Method	24
4.3.3	Type Selection PWA	25
4.4	Board Connection	26
4.4.1	Main Board	26
4.4.2	Type Selection Board	28
4.5	External Connection	28
4.5.1	Communication Connector [JP1]	28
4.5.2	Power Connection [J5]	29
4.6	Connection Cable List	30
4.6.1	LIMIT SWITCH ECDM [P/N:B1212A0339]	30
4.6.2	SOLENOID/SOL SENSOR ECDM [P/N:B1212A0341]	31
4.6.3	RVDT ECDM [P/N:B1212A0345]	31
4.6.4	WHEEL SENSOR ECDM [P/N:B1212A0346]	31

	DOC NO	MODEL	NAME	REV.	PAGE
	PL-ECDM0400-004	ECDM-400	Service Manual	1.01	4 of 65

4.6.5	MOTOR FB801D [P/N:B1212A0365]	32
4.6.6	CST CONNECTION ECDM PART B [P/N:B1212A0371].....	32
4.6.7	CST CONNECTION ECDM PART C [P/N: B1212A0372]	32
4.6.8	CST CONNECTION ECDM PART D [P/N: B1212A0373]	33
4.6.9	CST CONNECTION ECDM PART A [P/N: B1212A0380].....	33
4.6.10	SENSOR PATH L ECDM [P/N:B1212P0343]	33
4.6.11	SENSOR PATH R ECDM [P/N:B1212P0344]	34
4.6.12	PATH L ECDM-200 [P/N:B1212P0362]	34
4.6.13	PATH R ECDM PART B [P/N:B1212P0374].....	34
4.6.14	PATH R ECDM PART C [P/N:B1212P0375]	35
4.6.15	PATH R ECDM PART D [P/N:B1212P0376]	35
4.6.16	PATH L ECDM PART C [P/N:B1212P0377].....	35
4.6.17	PATH L ECDM PART D [P/N:B1212P0378]	36
4.6.18	CLUTCH ECDM [P/N:B1212A0340].....	36
4.6.19	DIV SOLENOID ECDM [P/N:B1212A0336]	36
4.6.20	CASSETTE ECDM-400 [P/N:B1212P0379].....	37
5	Maintenance	38
5.1	UNIT : Main Body	38
5.2	UNIT : Cash Cassette	43
5.3	UNIT : Reject Cassette	46
6	TROUBLE SHOOTING – ERROR CODES	49
6.1	Note Jam	49
6.2	Diverting Error	55
6.3	Sensor Error	56
6.4	Motor Speed Down	57
6.5	Cash Cassette Error	58
6.6	Reject Cassette Error	60
6.7	Abnormal Pick-up Operation	61
6.8	Jam in Cash Cassette	62
6.9	Over Reject	63
7	SPARE PART LIST	64
7.1	UNIT ECDM-400 Mechaism	64
7.2	UNIT Cash Cassette	65
7.3	UNIT Reject Cassette	65

	DOC NO	MODEL	NAME	REV.	PAGE
	PL-ECDM0400-004	ECDM-400	Service Manual	1.01	5 of 65

1 Preview

The document is user manual for service, repair and maintenance of ECDM-400.

2 Basic Specification and Structure

2.1 Basic Specification

Spec	NO	Item	Details
Basic Specification	1	Denomination	4
	2	Capacity (mm)	214
	3	Dispensing Speed (notes/sec)	4
	4	Note Size Available (mm)	Width: 100~162, Height: 62~78
	5	Double Note Detection	Mechanical Type
	6	Reject Box	50 notes
	7	Access	Front Access Type
	8	Dimension (mm)	270.5(W)x225(H)x420(D)
	9	Communication	RS-232C
	10	Near End	Optional Feature 1) Disabled: All banknotes are dispensed. 2) Enabled: 50 or 150 notes are remained before last transaction. (The amount of remaining notes can be selected by the position of the near end sensor.)
Electrical Spec.	1	Input Voltage	DC24V±10%
	2	Consumption Electricity (mA)	1) Standby Status : 160 2) Average Current, continuous : 7,500 3) Average Current, peak : 10,500
Operation Circumstances	1	Operation Temp (°C)	+5~+40
	2	Storage Temp (°C)	-10~+60
	3	Operation Humidity (%RH)	20~80
	4	Storage Humidity (%RH)	10~90

	DOC NO	MODEL	NAME	REV.	PAGE
	PL-ECDM0400-004	ECDM-400	Service Manual	1.01	6 of 65

2.2 Structure

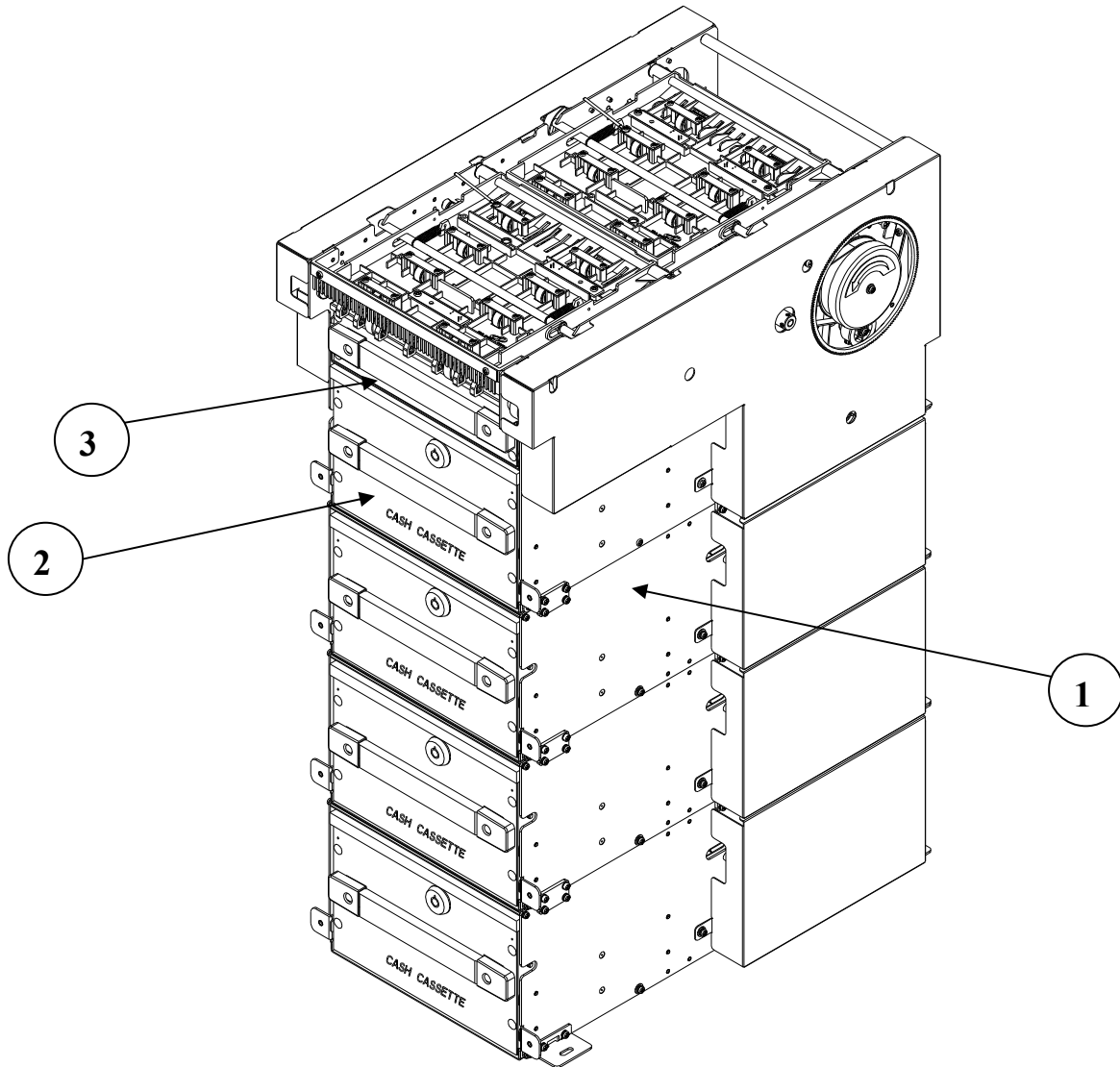

NO	PART NO	DESCRIPTION
1	B3001A0170	UNIT ECDM-400 MECHA
2	B3001A0171	UNIT CASH CASSETTE(ECDM-400 USD)
	B3001A0172	UNIT CASH CASSETTE(ECDM-400 EUR)
3	B3001A0138	UNIT REJECT CASSETTE

	DOC NO	MODEL	NAME	REV.	PAGE
	PL-ECDM0400-004	ECDM-400	Service Manual	1.01	7 of 65

3 Main Mechanism Configuration

3.1 UNIT ECDM-400 MECHA [B3001A0170]

3.1.1 Double Notes Detection Mechanism

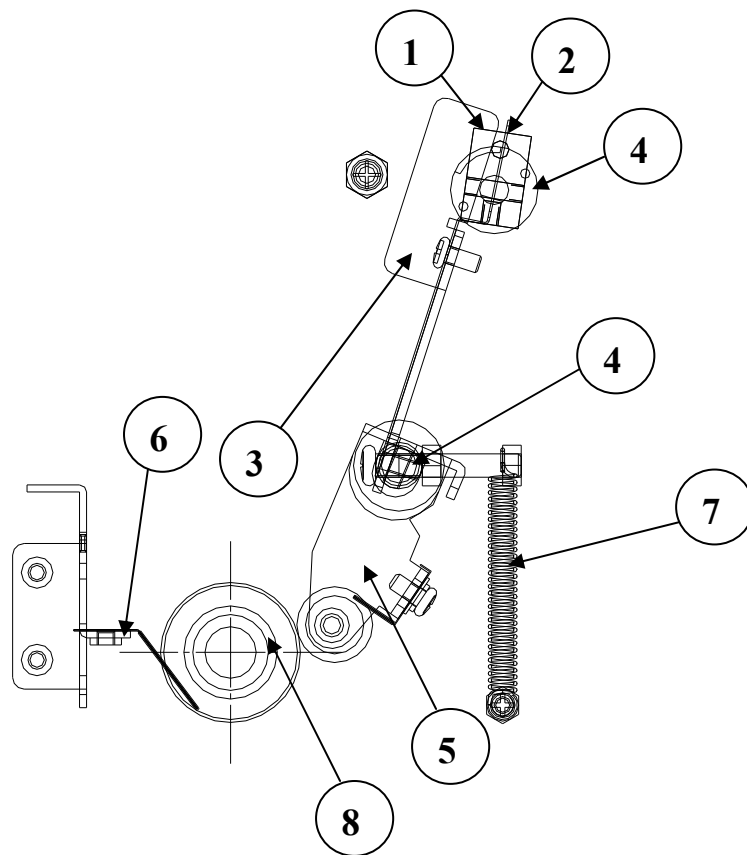

NO	PART NO	DESCRIPTION	FUNCTION
1	B1108P0089	BRACKET D/D HINGE	The mechanism detects double notes by measuring the thickness and amplication.
2	B2503P0029	PLATE D/D SENSOR	
3	B2104P0022	LEVER D/D HINGE	
4	B2817P0015	SENSOR LP06M3R MURATA MAGNETIC ANGLE	
5	B1004P0008	ARM D/D HINGE	
6	B2503P0030	PLATE CLEAN D/D ROLLER	
7	B2810P0037	SPRING RVDT TENSION VE ACDM	
8	B2803A0470	SHAFT ASSY CASH FEED2 ECDM	
9	B2803P0486	SHAFT HINGE D/D ECDM	

	DOC NO	MODEL	NAME	REV.	PAGE
	PL-ECDM0400-004	ECDM-400	Service Manual	1.01	8 of 65

3.1.2 Diverting Mechanism

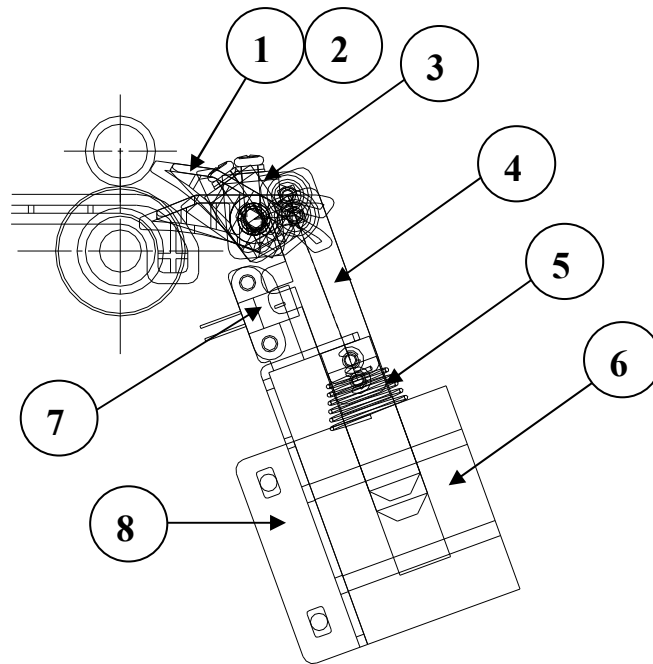

NO	PART NO	DESCRIPTION	FUNCTION
1	B1604P0298	GUIDE DIVERter ECDM	The mechanism activates diverters to be able to reject abnormal notes, double notes or folded notes before exit.
2	B1604P0299	GUIDE DIVERter ECDM2	
3	B2105P0013	LINK DIVERter 1	
4	B2105P0014	LINK DIVERter LCDM	
5	B2810P0040	SPRING SOLENOID DIV	
6	B2806P0020	SOLENOID MSS-1040 J08A ECDM(RoHS)	
7	B1212A0341	CABLE ASSY SOLENOID/SOL	
8	B1701P0015	HOLDER SOLENOID LCDM	

	DOC NO	MODEL	NAME	REV.	PAGE
	PL-ECDM0400-004	ECDM-400	Service Manual	1.01	9 of 65

3.1.3 Feeding Part

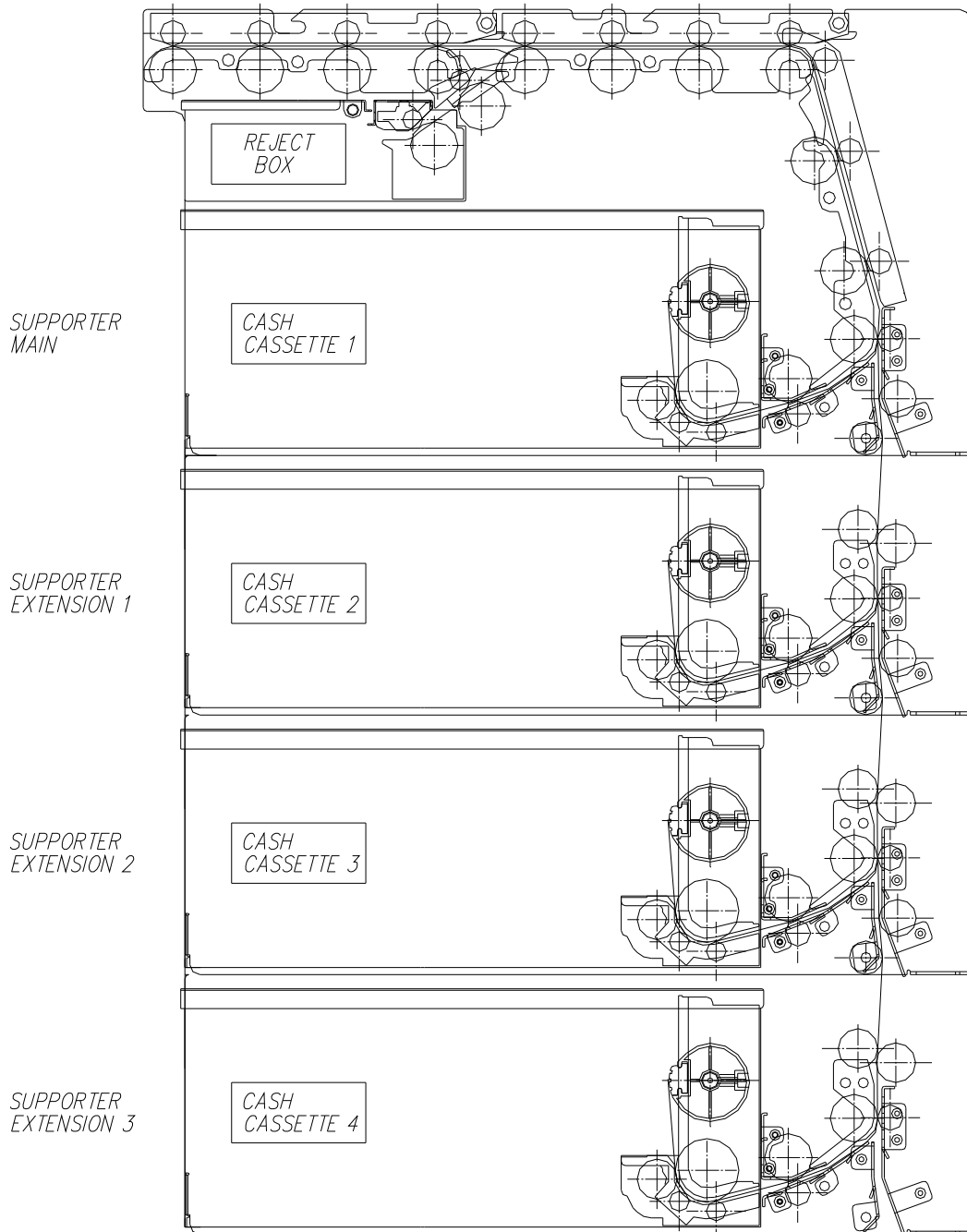

	DOC NO	MODEL	NAME	REV.	PAGE
	PL-ECDM0400-004	ECDM-400	Service Manual	1.01	10 of 65

1) SUPPORTER MAIN

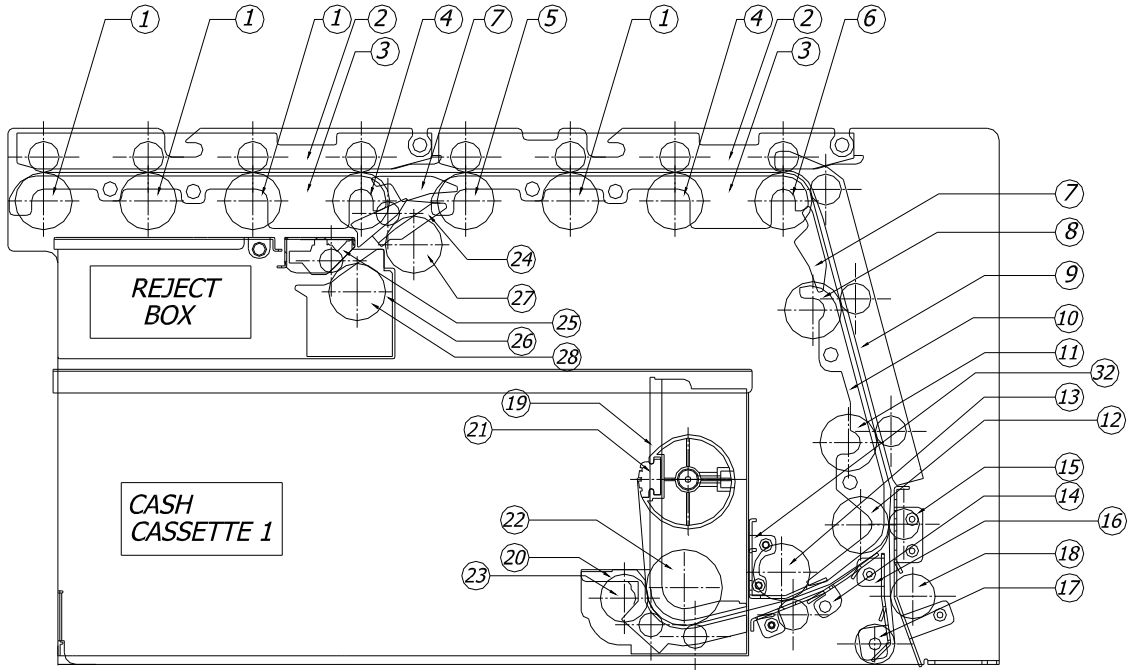

2) SUPPORTER EXTENSION 1

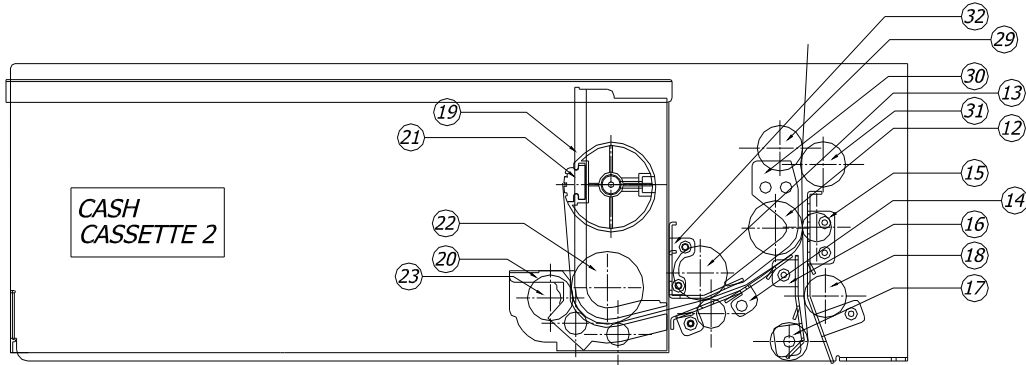

3) SUPPORTER EXTENSION 2

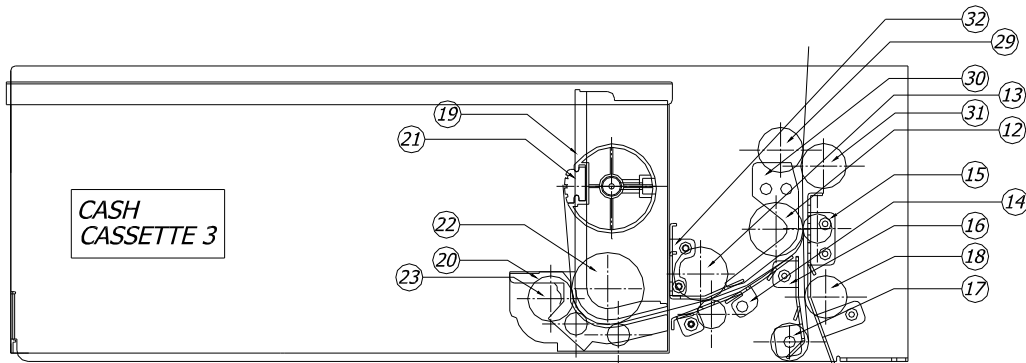

	DOC NO	MODEL	NAME	REV.	PAGE
	PL-ECDM0400-004	ECDM-400	Service Manual	1.01	11 of 65

4) SUPPORTER EXTENSION 3

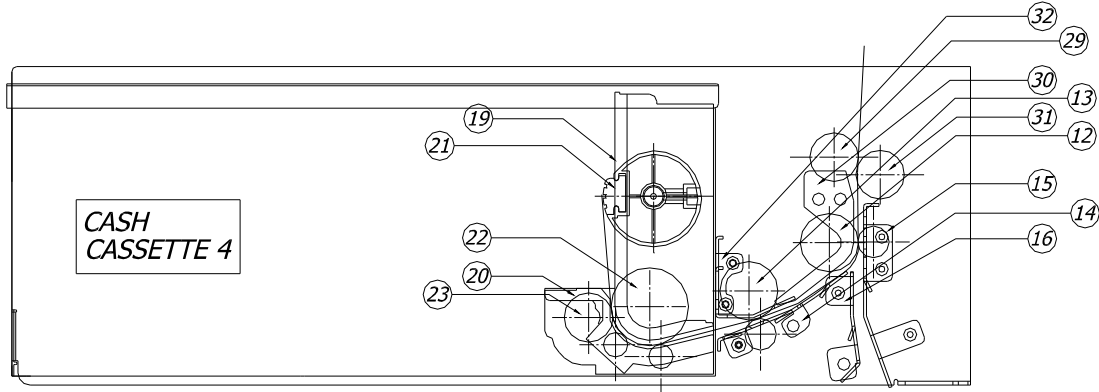

NO	PART NO	DESCRIPTION	FUNCTION
1	R2803A0155	SHAFT ASSY CASH FEED 6	NOTE FEEDING
2	B1604P0297	GUIDE CASH FEED 7 ECDM	NOTE GUIDE-OPEN/CLOSE
3	B1604P0296	GUIDE CASH FEED 6 ECDM	NOTE GUIDE
4	R2803A0154	SHAFT ASSY CASH FEED 5	NOTE FEEDING
5	B2803A0472	SHAFT ASSY CASH FEED 5 ECDM	NOTE FEEDING
6	R2803A0153	SHAFT ASSY CASH FEED 4	NOTE FEEDING
7	B1604P0298 B1604P0299	GUIDE DIVERTER ECDM GUIDE DIVERTER ECDM2	DIVERTING/GUIDE PATH
8	B2803A0471	SHAFT ASSY CASH FEED 3 ECDM	NOTE FEEDING
9	B1604P0088	GUIDE CASH FEED 5	NOTE GUIDE
10	B1604P0086	GUIDE CASH FEED 3	NOTE GUIDE
11	B2803A0470	SHAFT ASSY CASH FEED 2 ECDM	NOTE FEEDING
12	B2803A0469	SHAFT ASSY CASH FEED 1 ECDM	NOTE FEEDING
13	B2803A0473	SHAFT ASSY CASH FEED 0	NOTE FEEDING
14	B1604P0304	GUIDE PRESS 0	NOTE GUIDE
15	R1604P0100	GUIDE PRESS 1	NOTE GUIDE
16	R1604P0101	GUIDE PRESS 2	NOTE GUIDE
17	B2803P0179	SHAFT CASH FEED 9	NOTE FEEDING
18	B2803P0180	SHAFT CASH FEED 10	NOTE FEEDING
19	B1503P0242	FRAME PICKUP TOP	NOTE PICKUP&FEED GUIDE
20	B1503P0243	FRAME PICKUP BOTTOM	NOTE PICKUP&FEED GUIDE
21	B2803A0476	SHAFT ASSY PICKUP ROLLER ASSY ECDM	NOTE PICKUP
22	B2803A0478	SHAFT ASSY FEED ROLLER ECDM	NOTE FEEDING
23	B2803A0477	SHAFT ASSY ONEWAY ROLLER ECDM	NOTE SEPARATING
24	B1604P0300	GUIDE REJECT FEED	NOTE GUIDE
25	B1604P0294	GUIDE UPPER	NOTE GUIDE
26	B1604P0295	GUIDE LOWER	NOTE GUIDE
27	B2803A0475	SHAFT ASSY REJECT FEED	NOTE REJECT
28	B2803A0474	SHAFT ASSY REJECT	NOTE REJECT
29	B2803P0518	SHAFT CASH FEED 7 ECDM	NOTE FEEDING
30	B1604P0103	GUIDE CASH FEED 3 LCDM-2000	NOTE GUIDE
31	B2803P0178	SHAFT CASH FEED 8	NOTE FEEDING
32	B1604P0307	GUIDE PRESS PATH	NOTE GUIDE

	DOC NO	MODEL	NAME	REV.	PAGE
	PL-ECDM0400-004	ECDM-400	Service Manual	1.01	12 of 65

3.2 UNIT CASH CASSETTE

[B3001A0171: ECDM-400 USD/B3001A0172: ECDM-400 EUR]

3.2.1 Appearance

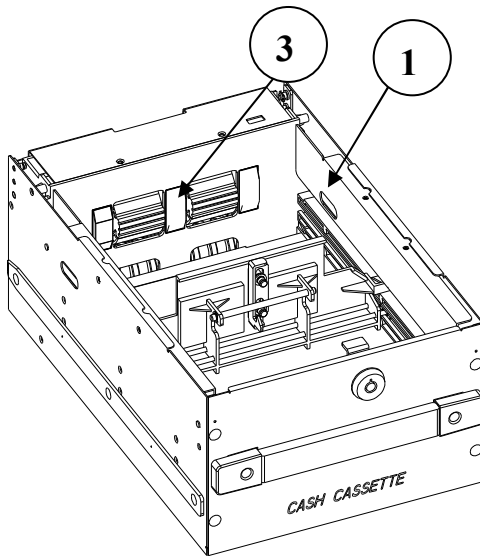
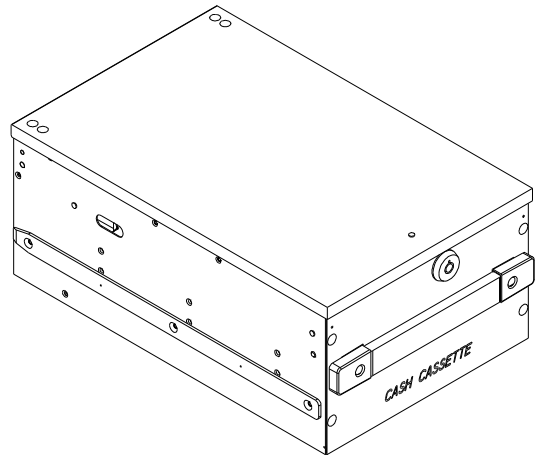
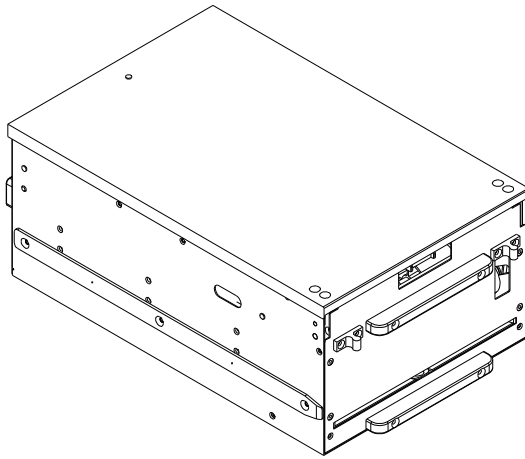

[CASH CASSETTE(USD)]

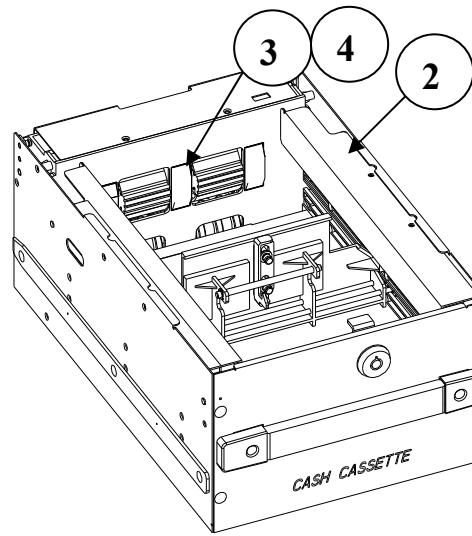

[CASH CASSETTE(EUR)]

NO	PART NO	DESCRIPTION
1	B1604P0305	GUIDE CASH INSERT L
	B1604P0306	GUIDE CASH INSERT R
2	B1604P0314	GUIDE CASH INSERT L EURO ECDM
	B1604P0315	GUIDE CASH INSERT R EURO ECDM
3	B2703P0007	RUBBER PICKUP PLATE
4	B1501P0019	FILM PICKUP PLATE EUR

	DOC NO	MODEL	NAME	REV.	PAGE
	PL-ECDM0400-004	ECDM-400	Service Manual	1.01	13 of 65

3.2.2 Configuration

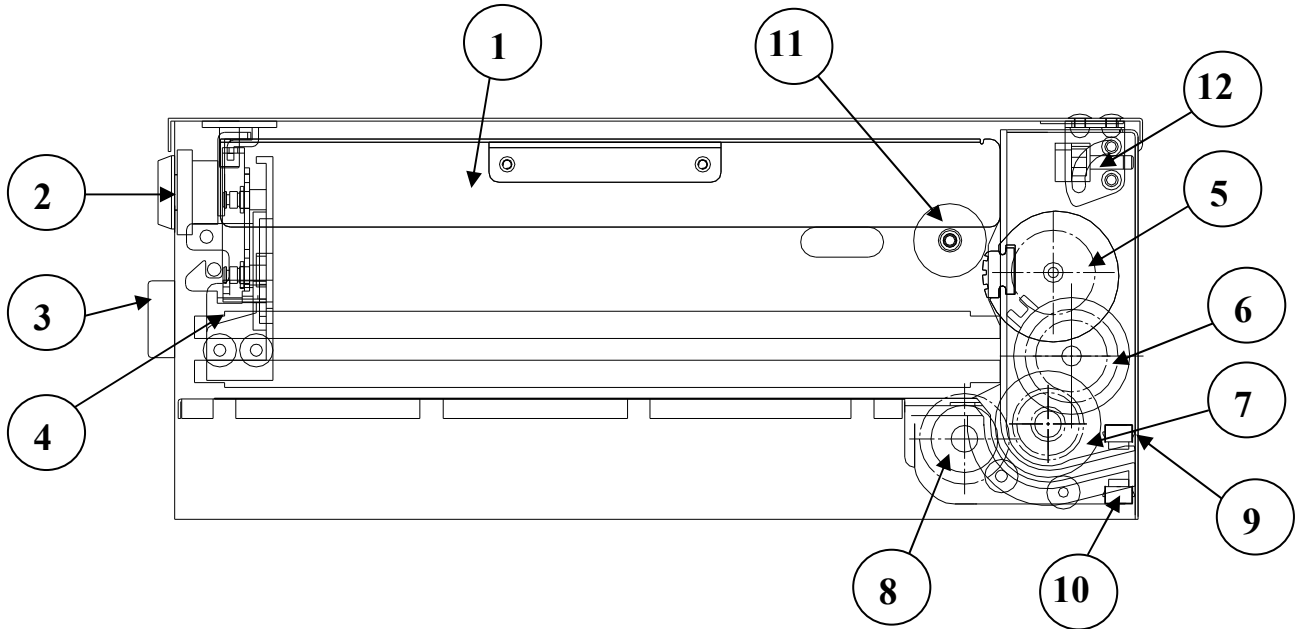

NO	PART NO	DESCRIPTION	FUNCTION
1	B1604P0305/6 B1604P0314/5	GUIDE CASH INSERT L/R (GUIDE CASH INSERT L/R EURO ECDM)	NOTE SIDE GUIDE
2	B2001P0014	KEY C805*S	LOCK/UNLOCK
3	B1702P0008	HANDLE E170-145 BRAMA	CARRYING
4	B2503P0031	PLATE CASH PUSHER	NOTE PUSH TO PICKUP ROLLER
5	B2803A0476	SHAFT ASSY PICKUP ROLLER ASSY ECDM	NOTE PICKUP
6	B2803A0478	SHAFT ASSY FEED ROLLER ECDM	NOTE FEEDING
7	B1205P0008	CLUTCH EL24PL ECDM	POWER TRANSPOTATION
8	B2803A0477	SHAFT ASSY ONEWAY ROLLER ECDM	NOTE SEPARATOR
9	B2817P0011	SENSOR ST310, RCV	Note Detection
10	B2817P0010	SENSOR G-310, EMIT	Note Detection
11	B2702P0053	ROLLER SPRING CASSETTE	Pressing Notes
12	B1212A0379	CABLE ASSY CASSETTE ECDM-400	

	DOC NO	MODEL	NAME	REV.	PAGE
	PL-ECDM0400-004	ECDM-400	Service Manual	1.01	14 of 65

3.3 UNIT REJECT CASSETTE [B3001A0138]

3.3.1 Appearance

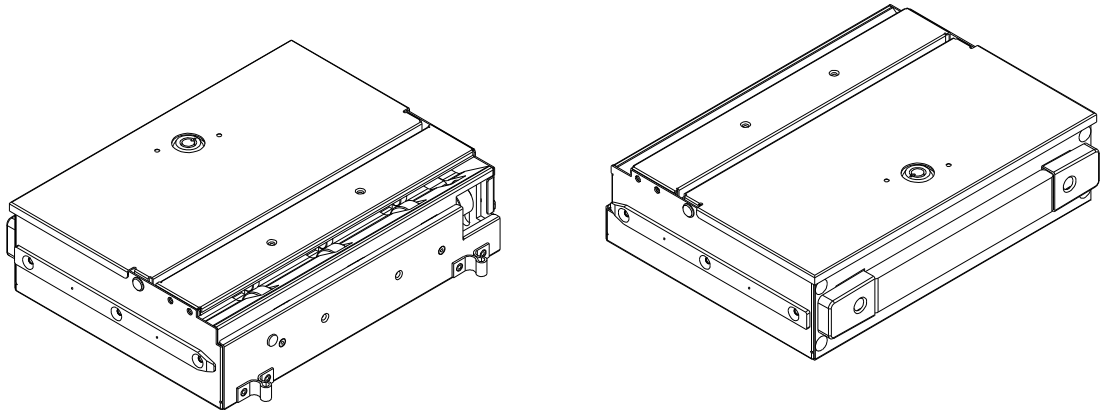

3.3.2 Configuration

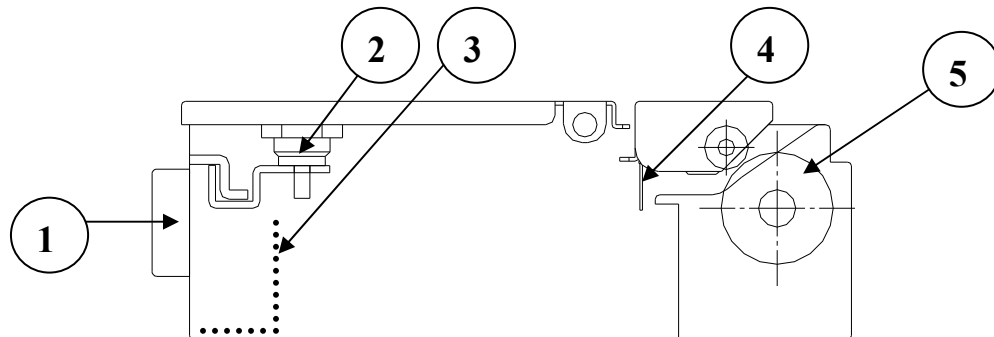



NO	PART NO	DESCRIPTION	FUNCTION
1	B1702P0008	HANDLE E170-145 BRAMA	Handle
2	B2001P0013	KEY CD 303S	LOCK/UNLOCK
3	B1501P0018	FILM REJECTBOX	GUIDE for Rejected notes
4	B1110P0008	BRUSH REJECT	Anti-Static Brush
5	B2803A0474	SHAFT ASSY REJECT	NOTE FEEDING

	DOC NO	MODEL	NAME	REV.	PAGE
	PL-ECDM0400-004	ECDM-400	Service Manual	1.01	15 of 65

3.4 Sensor Assignment

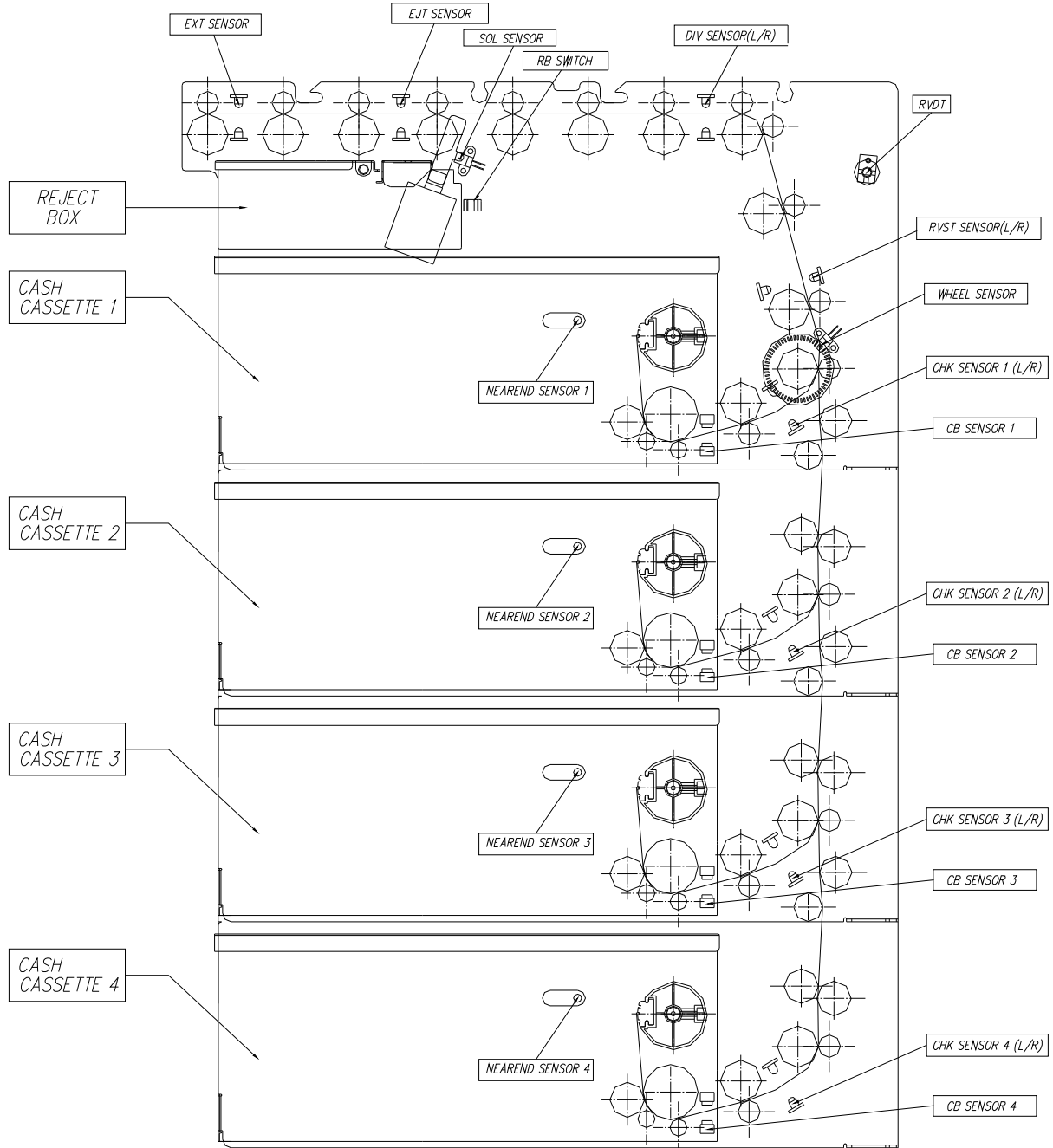
The sensors are shown in the below and can be checked by test program.



	DOC NO	MODEL	NAME	REV.	PAGE
	PL-ECDM0400-004	ECDM-400	Service Manual	1.01	16 of 65

NO	NAME	FUNCTION	TYPE
1	CB(Cashbox) SENSOR 1, 2, 3 and 4	Detection of banknotes in the Cash Cassette	OPTICAL(E-R*)
2	CHK(Check) SENSOR 1, 2, 3 and 4	Checking Skew, Length and Distance of banknotes	OPTICAL(E-R*)
3	RVST(RVDT Start) SENSOR	RVDT Triggerring Sensor	OPTICAL(E-R*)
4	DIV(Diverter) SENSOR	Diverter Solenoid Control	OPTICAL(E-R*)
5	EJT(Eject) SENSOR	Checking if Notes are rejected or not	OPTICAL(E-R*)
6	EXT(Exit) SENSOR	Counting and checking dispensed notes	OPTICAL(E-R*)
7	WHEEL SENSOR	Checking MOTOR SPEED : WHEEL Count	PHOTO INTERRUPT
8	SOL(Solenoid) SENSOR	Checking if Diverter is operated normal	PHOTO INTERRUPT
9	RVDT	Checking Double Detection	RVDT
10	RB(Reject Box) SWITCH	Checking if Reject Box exists or not.	LIMIT SWITCH
11	NEAREND SENSOR	Checking the remained notes in the cash cassette	OPTICAL(E-R*)

* E-R: EMIT SENSOR & RECEIVER SENSOR

	DOC NO	MODEL	NAME	REV.	PAGE
	PL-ECDM0400-004	ECDM-400	Service Manual	1.01	18 of 65

NAME	PART NO	DESCRIPTION
G1	B1601P0022	GEAR FEED LCDM(M:1,Z:27)
G2	B1601P0023	GEAR LCDM 27(M:1, Z:27)
G3	B1601P0066	GEAR IDLE Z18(M1.0)
G4	B1601P0068	GEAR IDLE Z24
G5	B1601P0070	GEAR FEED Z28(M1.0)
G6	B1601P0069	GEAR DRIVE Z27 CUT(M0.8)
G7	B1601P0002	GEAR FLANGE FEED(6.Z29.W5)
G8	B1601P0067	GEAR ONEWAY Z18(M1.0)
G9	B1601P0071	GEAR FEED Z18(M1.0)
P1	B2505P0021	PULLEY REVERSE(MXL42,7,8)
P2	B2505P0024	PULLEY FEED(XL21,8)
P3	B2505P0062	PULLEY MOTOR XL11 ECMD-400
P4	B2505P0025	PULLEY CASH FEED 4
P5	B2505P0020	PULLEY FEED(XL 15,8)
P6	B2505P0011	PULLEY PULLEY DRV MXL17 PCR-XXX
P7	B2505P0056	PULLEY XL12
P8	B2505P0055	PULLEY REVERSE ECMD(MXL42)
P9	B2505P0054	PULLEY XL16
P10	B2505P0022	PULLEY FEED(12XL)
P11	B2505P0023	PULLEY IDLE(15XL)
R1	B2702P0007	ROLLER IDLE CROWN(18)
R2	B2702P0033	ROLLER IDLE CROWN(16)
R3	B2702P0051	ROLLER FEED CROWN
MOTOR	B2203P0005	CLUTCH EL24PL ECMD
CLUTCH	B1205P0008	MOTOR FB-801D(BLDC)

* G: Gear, P: Pulley, R: Roller.

	DOC NO	MODEL	NAME	REV.	PAGE
	PL-ECDM0400-004	ECDM-400	Service Manual	1.01	19 of 65

4 H/W Configuration

4.1 Main Board

4.1.1 Specification

- ▶ CPU
→ STR710FZ2T6
- ▶ ROM
→ 128Kbyte, PLCC, SST39VF010
- ▶ RAM
→ 64Kbyte, CPU Bulit-in Memory
- ▶ MAIN CLOCK
→ 16MHz
- ▶ DISPLAY
→ 7-SEGMENT LED
- ▶ SENSOR CIRCUIT
→ DAC : AD8804
→ ADC : ADC0804
- ▶ BLDC MOTOR CONTROL
→ CONTROLLER : MC33035(CLOSED LOOP SPEED CONTROL)
→ DRIVER : SLA5064(MOSFET ARRAY)
- ▶ SOLENOID & CLUTCH CONTROL
→ DRIVER : SMA4030(POWER TR ARRAY), BDW93C(POWER TR)
- ▶ COMMUNICATION
→ RS232 SRIVER : SP232ECN

	DOC NO	MODEL	NAME	REV.	PAGE
	PL-ECDM0400-004	ECDM-400	Service Manual	1.01	20 of 65

4.1.2 Block Diagram

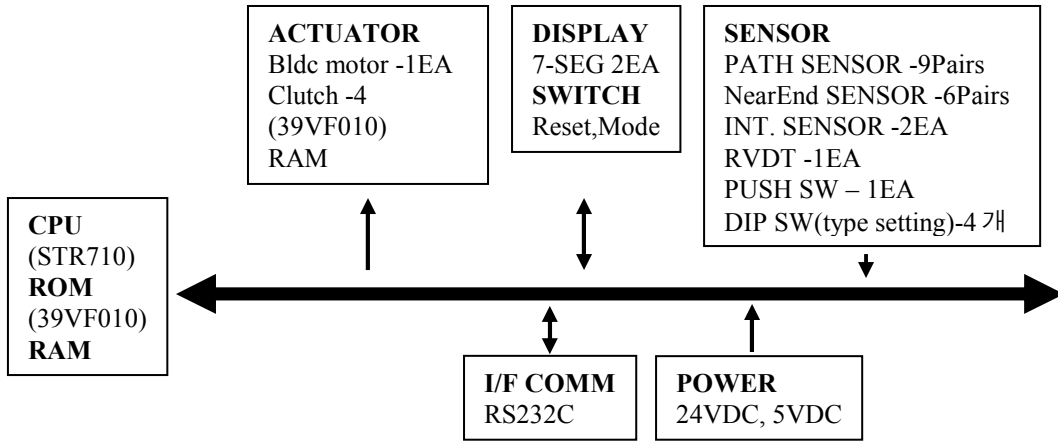

4.1.3 Layout of Main Board

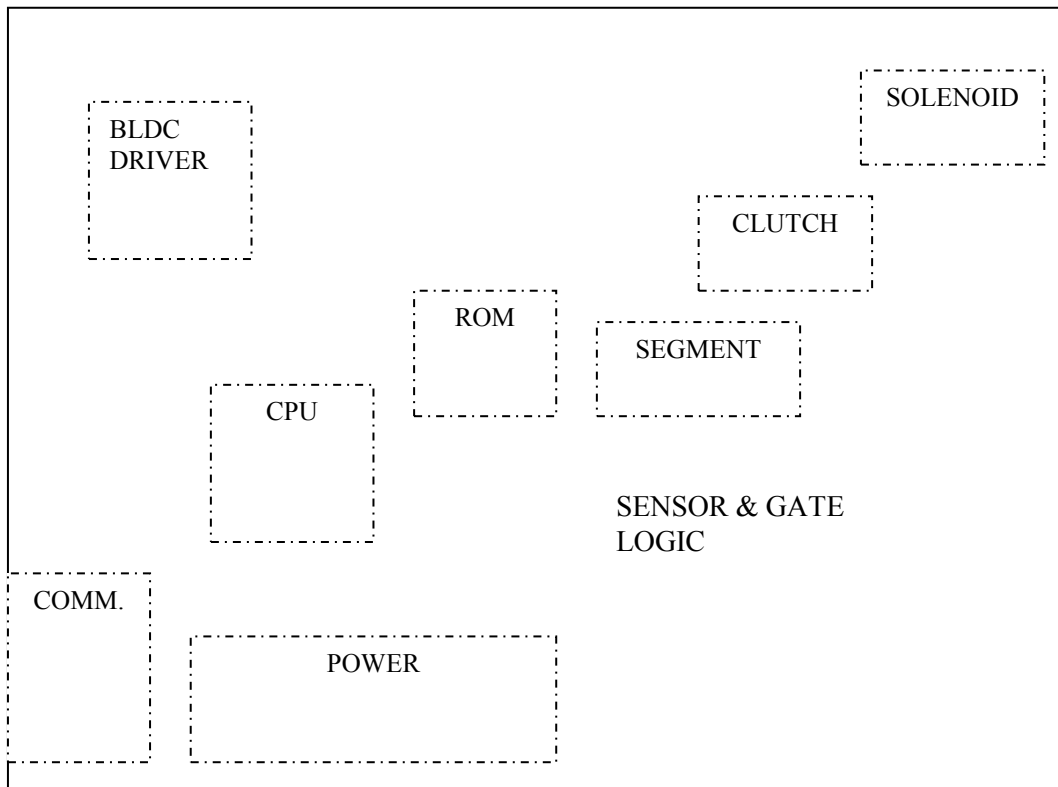

	DOC NO	MODEL	NAME	REV.	PAGE
	PL-ECDM0400-004	ECDM-400	Service Manual	1.01	21 of 65

4.2 Sensor Board

4.2.1 Sensor Circuit

► PATH SENSOR

- 1) PHOTO DIODE: KEL-1KL2 (KODENSHI)
- 2) PHOTO TR : KST-1KLB (KODENSHI)

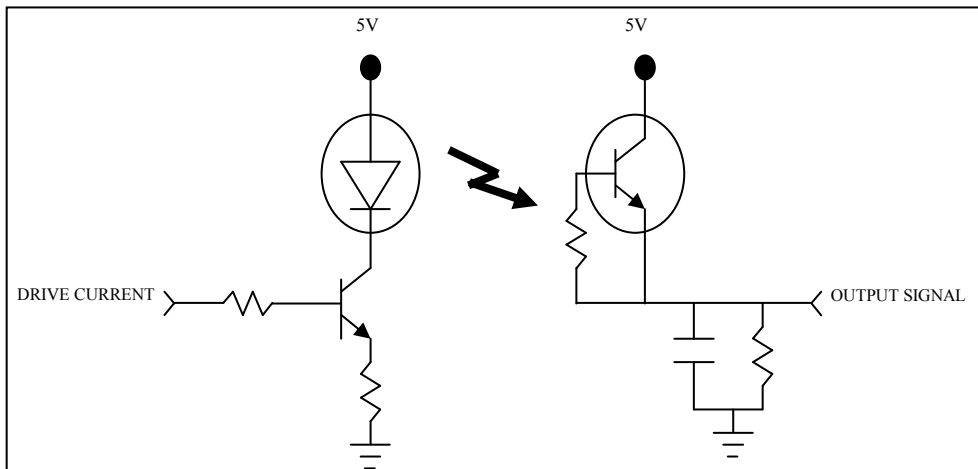

► NEAREND SENSOR

- 1) PHOTO DIODE: KEL-1KL2 (KODENSHI)
- 2) PHOTO TR : KST-1KLB (KODENSHI)

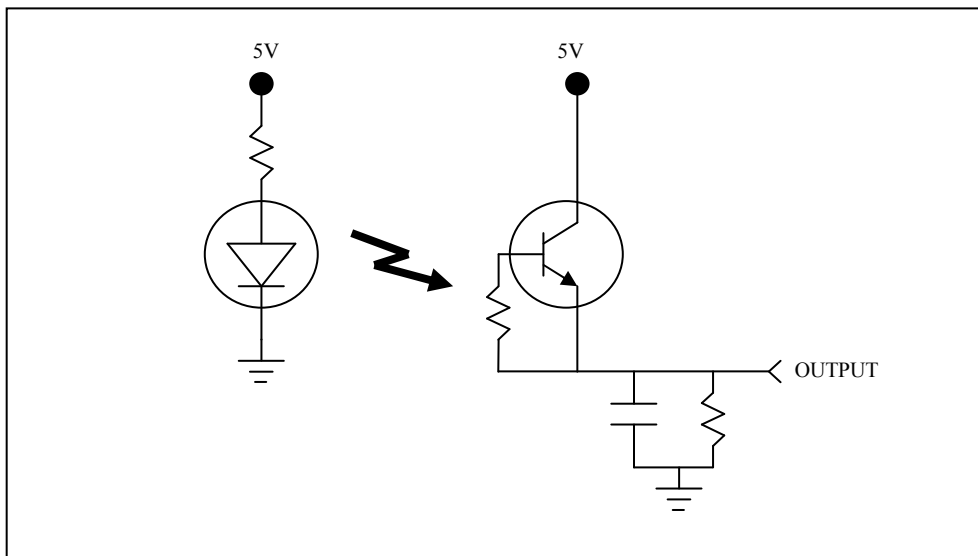

	DOC NO	MODEL	NAME	REV.	PAGE
	PL-ECDM0400-004	ECDM-400	Service Manual	1.01	22 of 65

► PHOTO INTERRUPT SENSOR (WHEEL, SOL)

1) SG255 (KODENSHI)

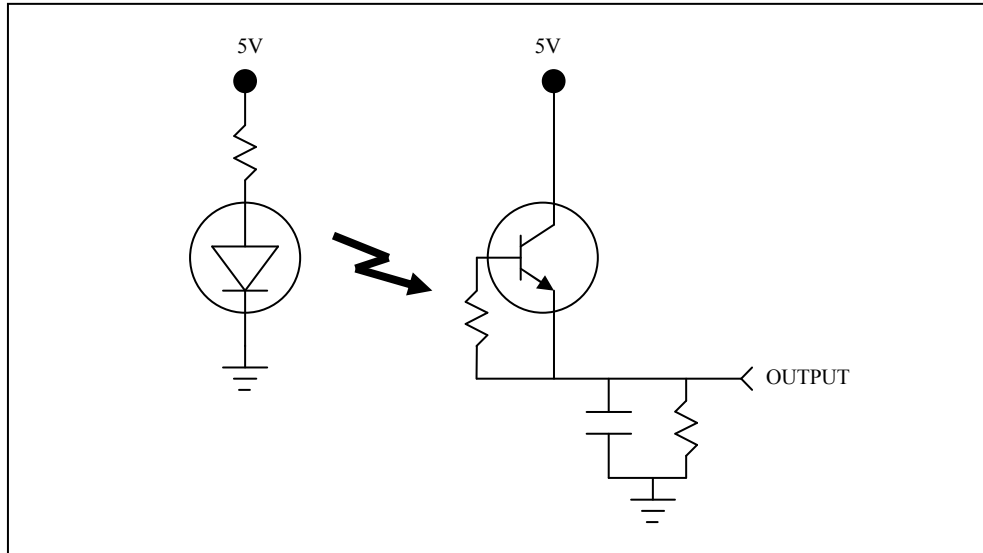

► CASH BOX SENSOR

1) PHOTO DIODE : G-310 (KODENSHI)

2) PHOTO TR : ST-310 (KODENSHI)

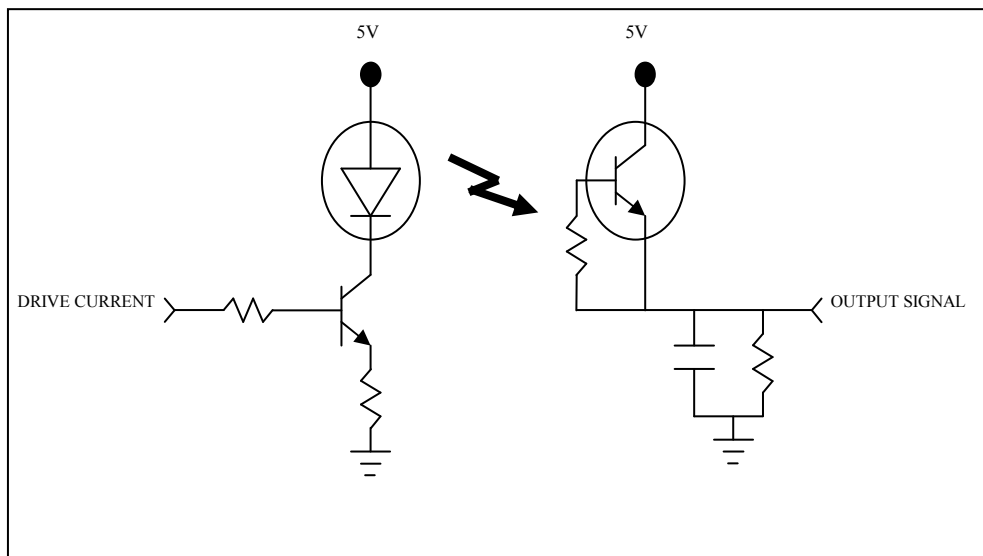

	DOC NO	MODEL	NAME	REV.	PAGE
	PL-ECDM0400-004	ECDM-400	Service Manual	1.01	23 of 65

4.2.2 Sensor PWA

▶ PATH SENSOR

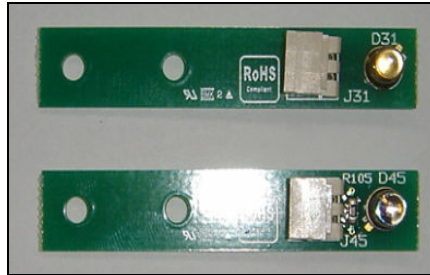

P/N: RPA000006B

P/N: RPA000007B

▶ NEAREND SENSOR

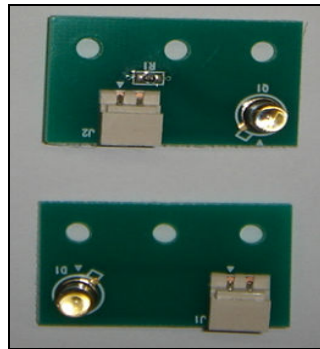

P/N: RPA000037B

P/N: RPA000037C

▶ PHOTO INTERRUPT SENSOR

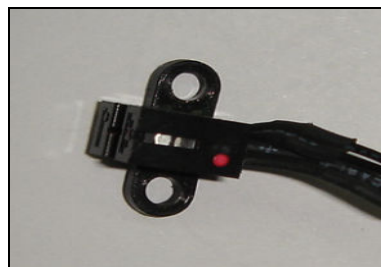

P/N: B1212A0346 (CABLE ASSY WHEEL SENSOR)
P/N: B1212A0341 (CABLE ASSY SOL SENSOR)

▶ CASH BOX SENSOR

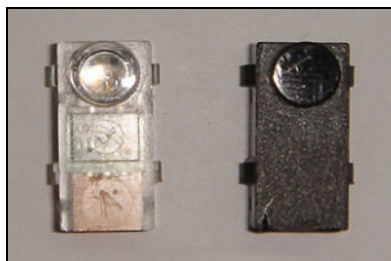

P/N: B2817P0010 (G-310)
P/N: B2817P0011 (ST-310)

	DOC NO	MODEL	NAME	REV.	PAGE
	PL-ECDM0400-004	ECDM-400	Service Manual	1.01	24 of 65





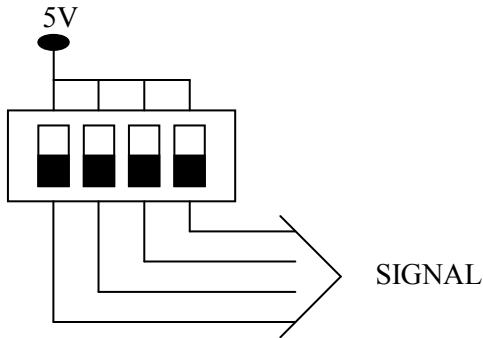



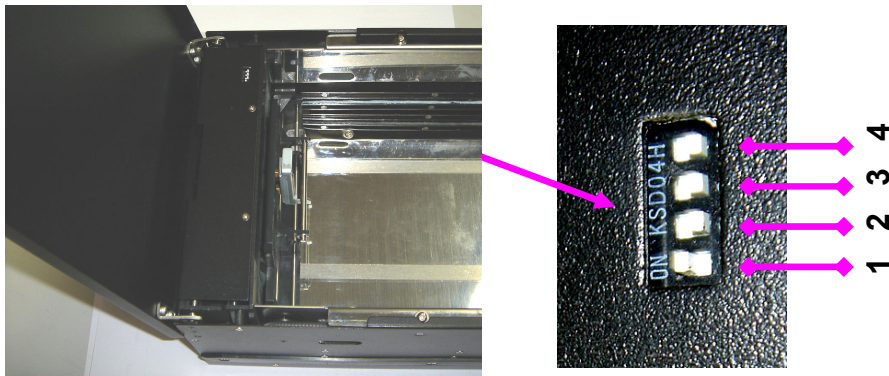







4.3 Type Selection Board

4.3.1 Type Selection Circuit



4.3.2 Type Selection Method



# TYPE 1 – SW1 ON	# TYPE 2 – SW2 ON
SW ON OFF <div style="display: flex; justify-content: space-around; margin-top: 5px;"> <div style="text-align: center;">1 </div> <div style="text-align: center;">2 </div> <div style="text-align: center;">3 </div> <div style="text-align: center;">4 </div> </div>	SW ON OFF <div style="display: flex; justify-content: space-around; margin-top: 5px;"> <div style="text-align: center;">1 </div> <div style="text-align: center;">2 </div> <div style="text-align: center;">3 </div> <div style="text-align: center;">4 </div> </div>
# TYPE 3 – SW3 ON	# TYPE 4 – SW4 ON
SW ON OFF <div style="display: flex; justify-content: space-around; margin-top: 5px;"> <div style="text-align: center;">1 </div> <div style="text-align: center;">2 </div> <div style="text-align: center;">3 </div> <div style="text-align: center;">4 </div> </div>	SW ON OFF <div style="display: flex; justify-content: space-around; margin-top: 5px;"> <div style="text-align: center;">1 </div> <div style="text-align: center;">2 </div> <div style="text-align: center;">3 </div> <div style="text-align: center;">4 </div> </div>

	DOC NO	MODEL	NAME	REV.	PAGE
	PL-ECDM0400-004	ECDM-400	Service Manual	1.01	25 of 65

4.3.3 Type Selection PWA

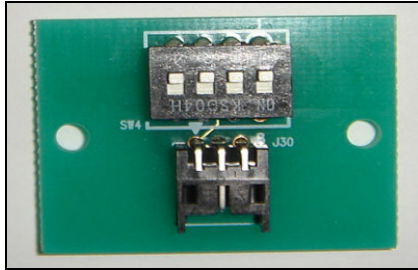



P/N: RPA000041B

	DOC NO	MODEL	NAME	REV.	PAGE
	PL-ECDM0400-004	ECDM-400	Service Manual	1.01	26 of 65

4.4 Board Connection

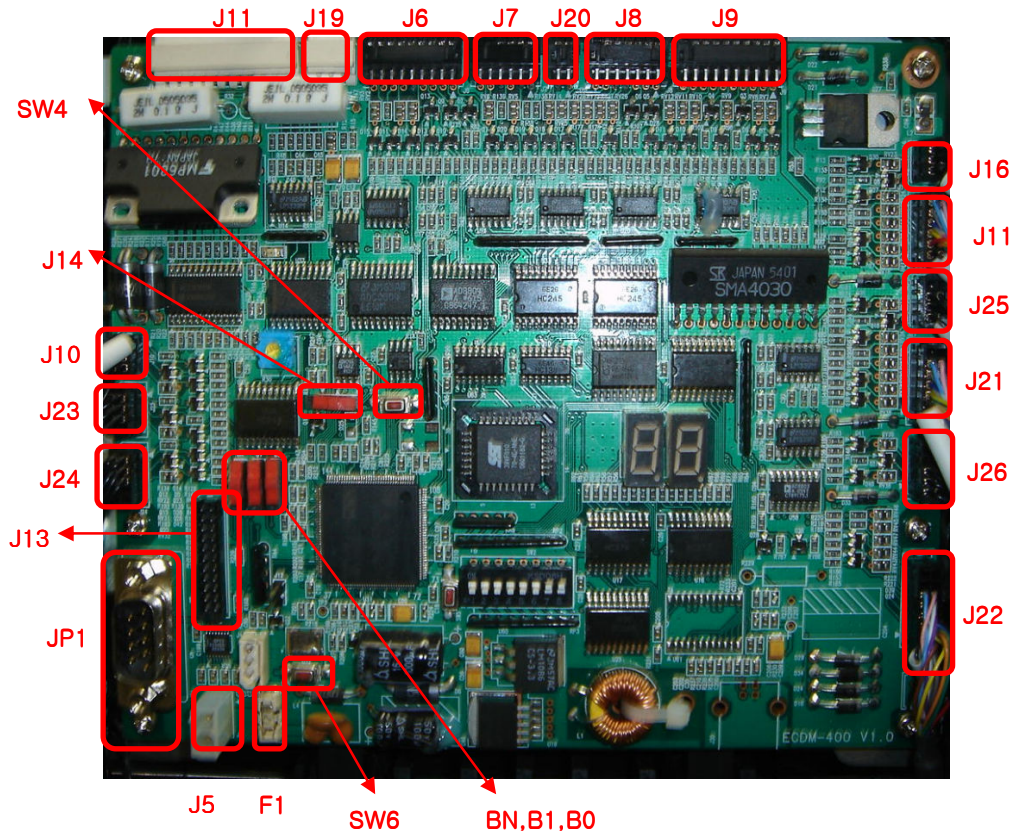
4.4.1 Main Board



	DOC NO	MODEL	NAME	REV.	PAGE
	PL-ECDM0400-004	ECDM-400	Service Manual	1.01	27 of 65

NO	DESCRIPTION
J1	Motor
J19	RVDT
J6	EXT,EJT Emission Sensor, DIV_L(Motor Side) Emission and Reception Sensor, RVST_L(Motor Side) Emission Sensor, the 1 st High END Emission Sensor, 1st High CHK_L(Motor Side) Emission and Reception Sensor
J7	Solenoid, Sol Sensor, Reject box Detection Switch
J20	WHEEL Sensor
J8	the 1 st High CASSETTE CONNECTOR(Clutch & CASSETTE type setting dip Switch & CASSETTE Sensor)
J9	EXT,EJT Reception Sensor, DIV_R(Opposite Side to Motor) Emission and Reception Sensor, RVST_R(Opposite Side to Motor) Emission and Reception Sensor, the 1 st High END Reception Sensor, the 1 st High CHK_R(Opposite Side to Motor) Emission and Reception Sensor
J16	The 2 nd High END Reception Sensor, The 2 nd High CHK_R(Opposite Side to Motor) Emission and Reception Sensor
J11	The 2 nd High CASSETTE CONNECTOR(Clutch & CASSETTE type setting dip Switch & CASSETTE Sensor)
J25	The 3 rd High END Reception Sensor, the 3 rd High CHK_R(Opposite Side to Motor) Emission and Reception Sensor
J21	The 3 rd CASSETTE CONNECTOR(Clutch & CASSETTE type Setting dip Switch & CASSETTE Sensor)
J26	The 4 th High END Reception Sensor, the 4 th High CHK_R(Opposite Side to Motor) Emission and Reception Sensor
J22	4 th CASSETTE CONNECTOR(Clutch & CASSETTE type Setting dip Switch & CASSETTE Sensor)
BN,B1,B0	Boot Mode select Switch (All should be set to ON)
SW6	Switch for Flash writing
J5	Power CONNECTOR
JP1	RS232 Communication CONNECTOR
J13	JTAG CONNECTOR
J24	The 4 th High END Emission Sensor, the 4 th CHK_L(Motor Side) Emission and Reception Sensor
J23	The 3 rd High END Emission Sensor, the 3 rd High CHK_L(Motor Side) Emission and Reception Sensor
J10	The 2 nd High END Emission Sensor, the 2 nd High CHK_L(Motor Side) Emission and Reception Sensor
F1	Fuse (125V/5A)
J14	Select to use Watchdog (For use, it should be turned to ON to right handed direction and for disabling, to left handed direction. In case downloading onto ROM, it should be disabled.)
SW4	Reset Switch

	DOC NO	MODEL	NAME	REV.	PAGE
	PL-ECDM0400-004	ECDM-400	Service Manual	1.01	28 of 65

4.4.2 Type Selection Board

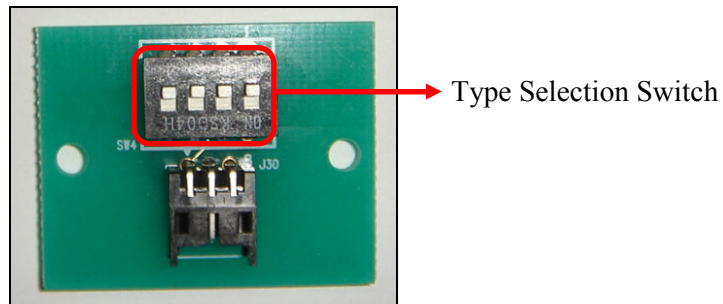

4.5 External Connection

4.5.1 Communication Connector [JP1]

► Type : 9P-DSUB MALE

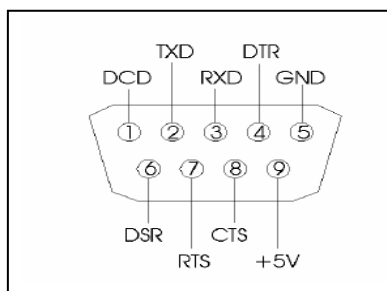

PIN NO.	DESCRIPTION
1	Not Used
2	RXD(Received Data)
3	TXD(Transmitted Data)
4	Not Used
5	GND
6	Not used
7	Not used
8	Not used
9	Not used

	DOC NO	MODEL	NAME	REV.	PAGE
	PL-ECDM0400-004	ECDM-400	Service Manual	1.01	29 of 65

4.5.2 Power Connection [J5]

► Type : 5566VWO-02 (MOLEX):

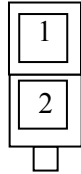

PIN NO.	NAME
1	24VDC
2	GND

	DOC NO	MODEL	NAME	REV.	PAGE
	PL-ECDM0400-004	ECDM-400	Service Manual	1.01	30 of 65

4.6 Connection Cable List

NAME	DESCRIPTION	PART NO.
	LIMIT SWITCH ECDM	B1212A0339
J7	SOLENOID/SOL SENSOR ECDM	B1212A0341
J19	RVDT ECDM	B1212A0345
J20	WHEEL SENSOR ECDM	B1212A0346
J1	MOTOR FB801D ECDM-200	B1212A0365
J11	CST CONNECTION ECDM PART B	B1212A0371
J21	CST CONNECTION ECDM PART C	B1212A0372
J22	CST CONNECTION ECDM PART D	B1212A0373
J8	CST CONNECTION ECDM PART A	B1212A0380
J6	SENSOR PATH L ECDM	B1212P0343
J9	SENSOR PATH R ECDM	B1212P0344
J10	PATH L ECDM-200	B1212P0362
J16	PATH R ECDM PART B	B1212P0374
J25	PATH R ECDM PART C	B1212P0375
J26	PATH R ECDM PART D	B1212P0376
J23	PATH L ECDM PART C	B1212P0377
J24	PATH L ECDM PART D	B1212P0378
	CLUTCH ECDM	B1212A0340
	DIV SOLENOID ECDM	B1212A0336
	CASSETTE ECDM-400	B1212P0379

4.6.1 LIMIT SWITCH ECDM [P/N:B1212A0339]

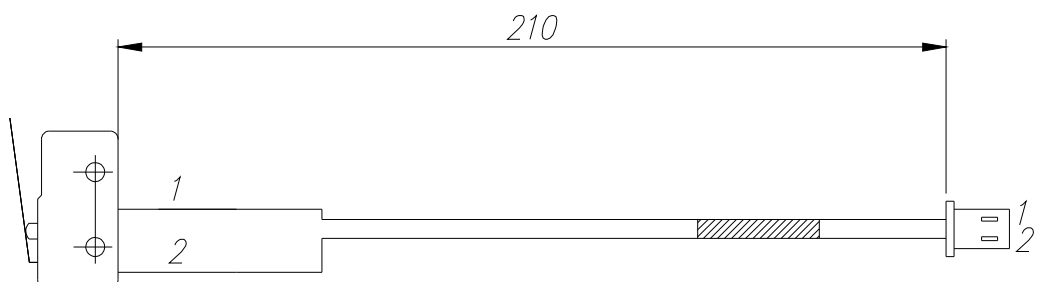

SMH250-02, YEONHO

	DOC NO	MODEL	NAME	REV.	PAGE
	PL-ECDM0400-004	ECDM-400	Service Manual	1.01	31 of 65

4.6.2 SOLENOID/SOL SENSOR ECDM [P/N:B1212A0341]

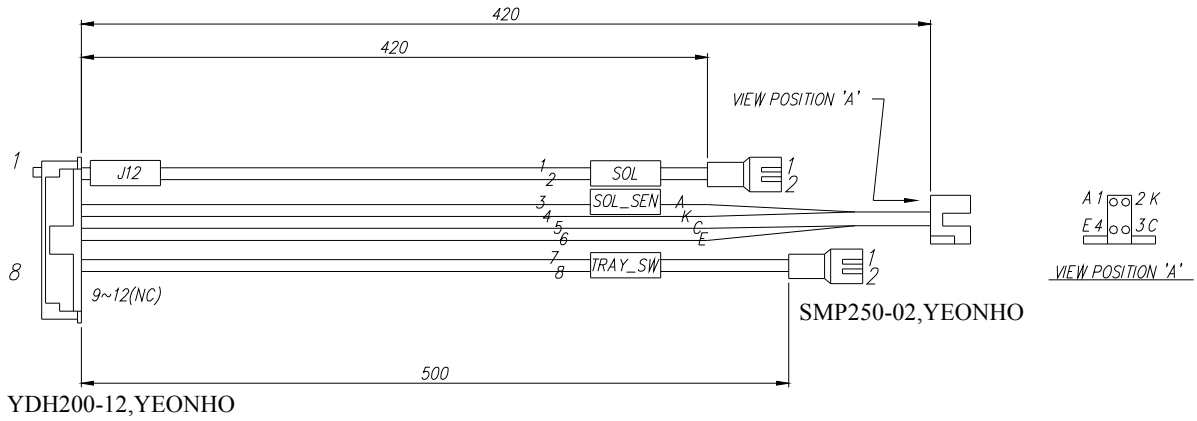

4.6.3 RVDT ECDM [P/N:B1212A0345]

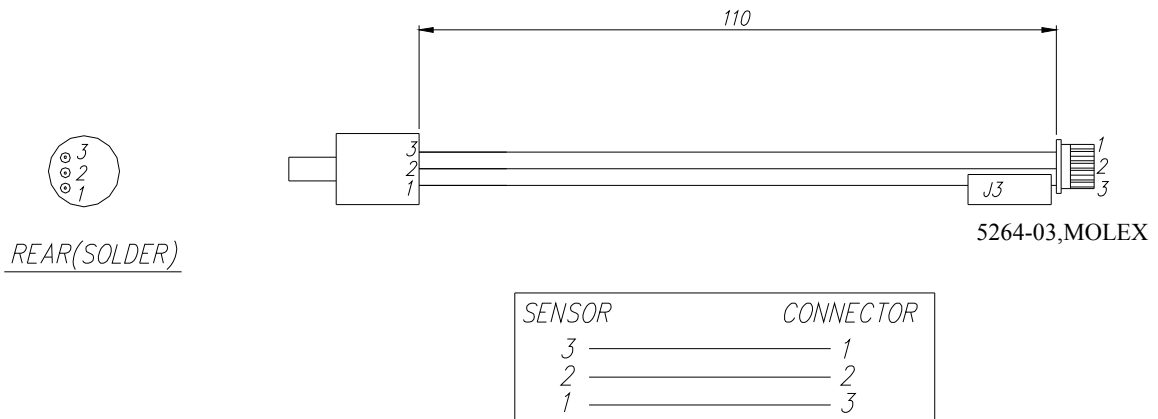

4.6.4 WHEEL SENSOR ECDM [P/N:B1212A0346]

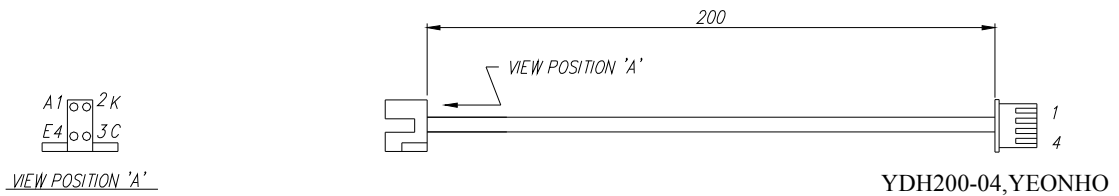

	DOC NO	MODEL	NAME	REV.	PAGE
	PL-ECDM0400-004	ECDM-400	Service Manual	1.01	32 of 65

4.6.5 MOTOR FB801D [P/N:B1212A0365]

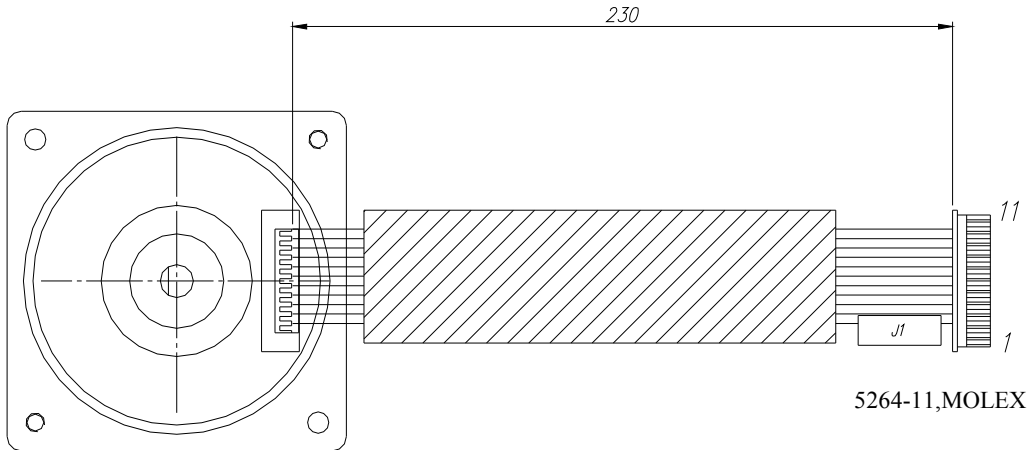

4.6.6 CST CONNECTION ECDCM PART B [P/N:B1212A0371]

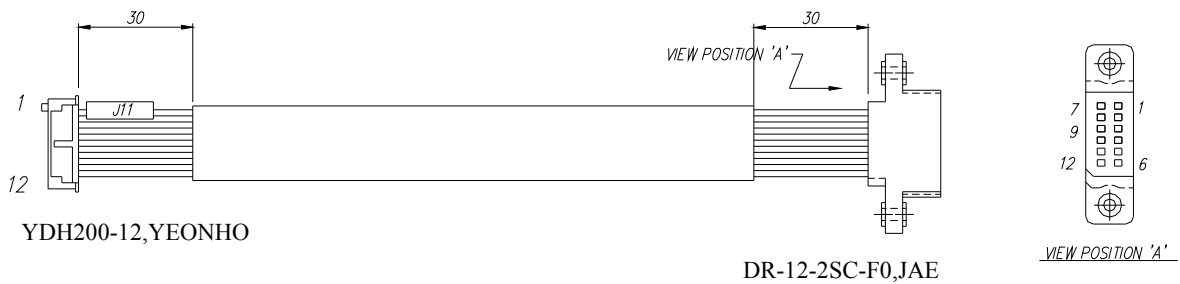

4.6.7 CST CONNECTION ECDCM PART C [P/N: B1212A0372]



	DOC NO	MODEL	NAME	REV.	PAGE
	PL-ECDM0400-004	ECDM-400	Service Manual	1.01	33 of 65

4.6.8 CST CONNECTION ECDCM PART D [P/N: B1212A0373]

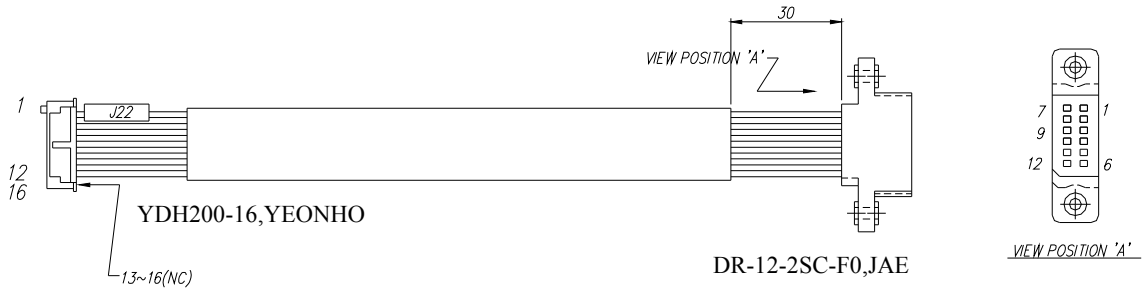

4.6.9 CST CONNECTION ECDCM PART A [P/N: B1212A0380]

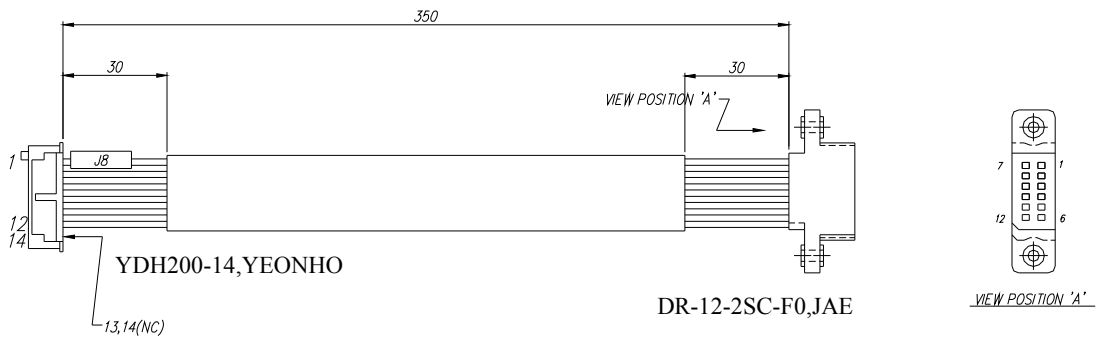

4.6.10 SENSOR PATH L ECDCM [P/N: B1212P0343]

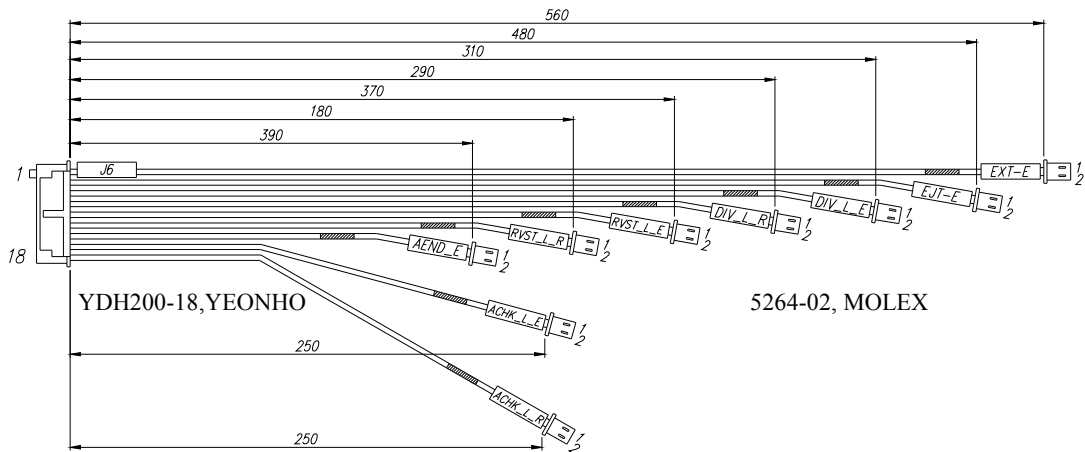

	DOC NO	MODEL	NAME	REV.	PAGE
	PL-ECDM0400-004	ECDM-400	Service Manual	1.01	34 of 65

4.6.11 SENSOR PATH R ECDM [P/N:B1212P0344]

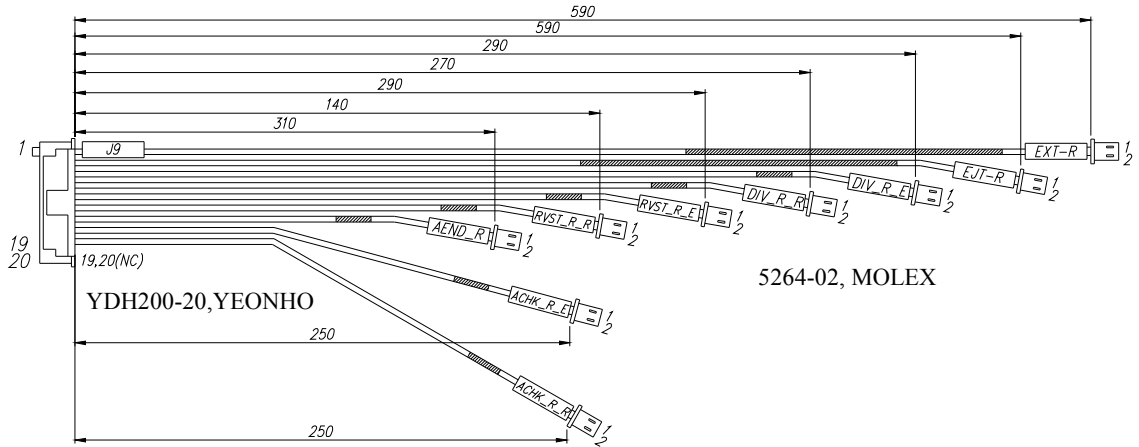

4.6.12 PATH L ECDM-200 [P/N:B1212P0362]

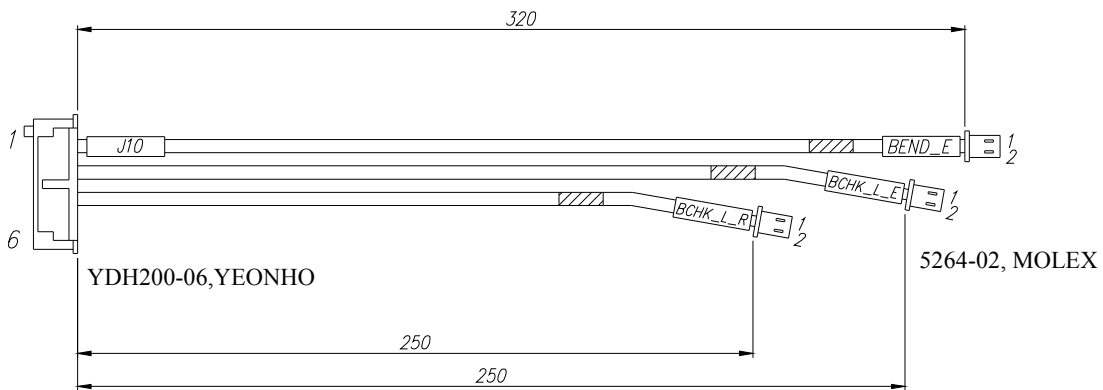

4.6.13 PATH R ECDM PART B [P/N:B1212P0374]

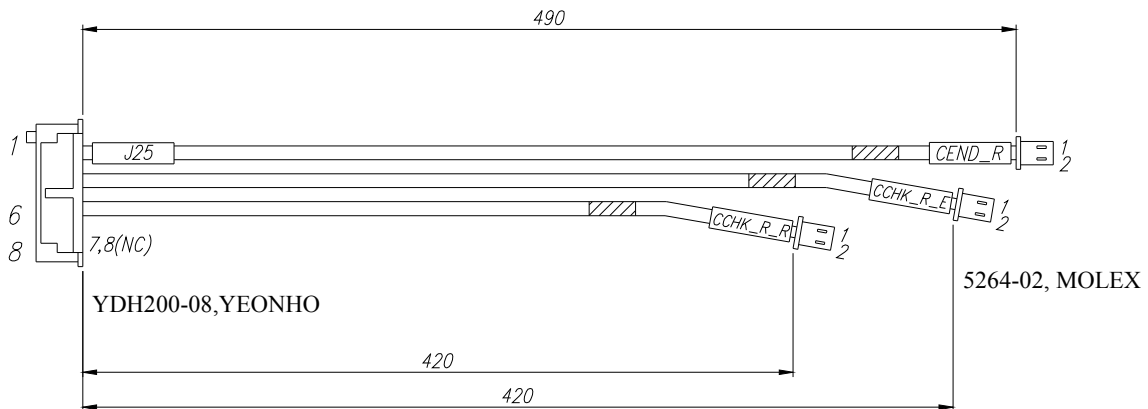

	DOC NO	MODEL	NAME	REV.	PAGE
	PL-ECDM0400-004	ECDM-400	Service Manual	1.01	35 of 65

4.6.14 PATH R ECDM PART C [P/N:B1212P0375]

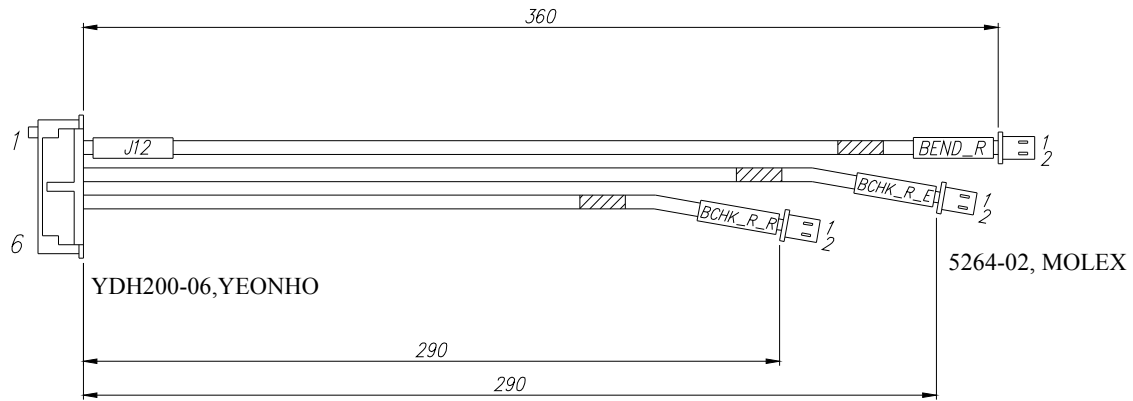

4.6.15 PATH R ECDM PART D [P/N:B1212P0376]

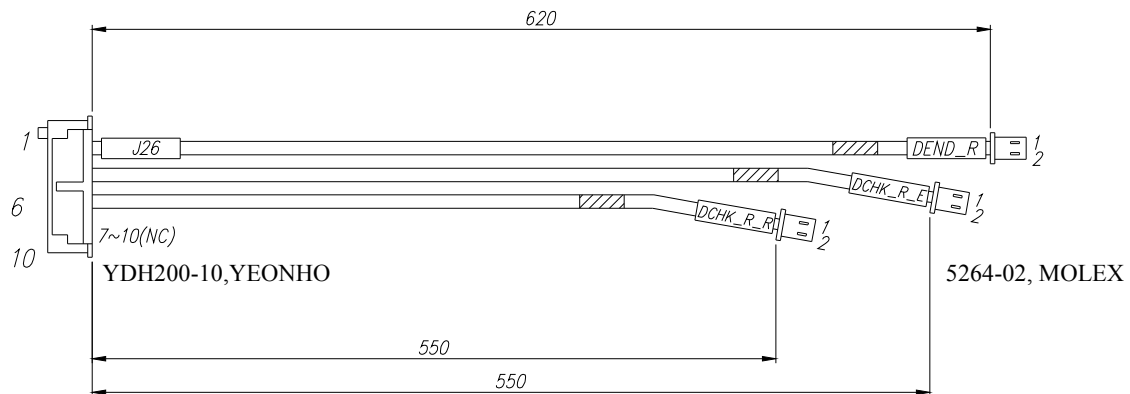

4.6.16 PATH L ECDM PART C [P/N:B1212P0377]

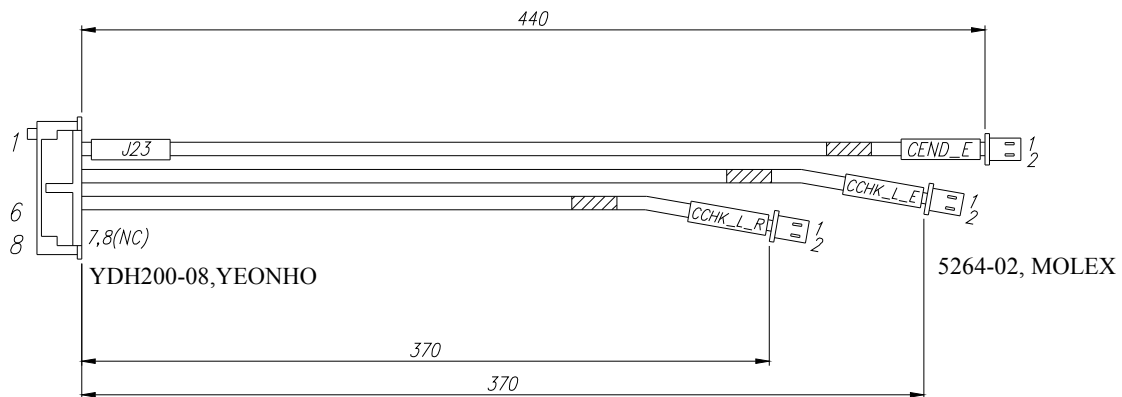

	DOC NO	MODEL	NAME	REV.	PAGE
	PL-ECDM0400-004	ECDM-400	Service Manual	1.01	36 of 65

4.6.17 PATH L ECDM PART D [P/N:B1212P0378]

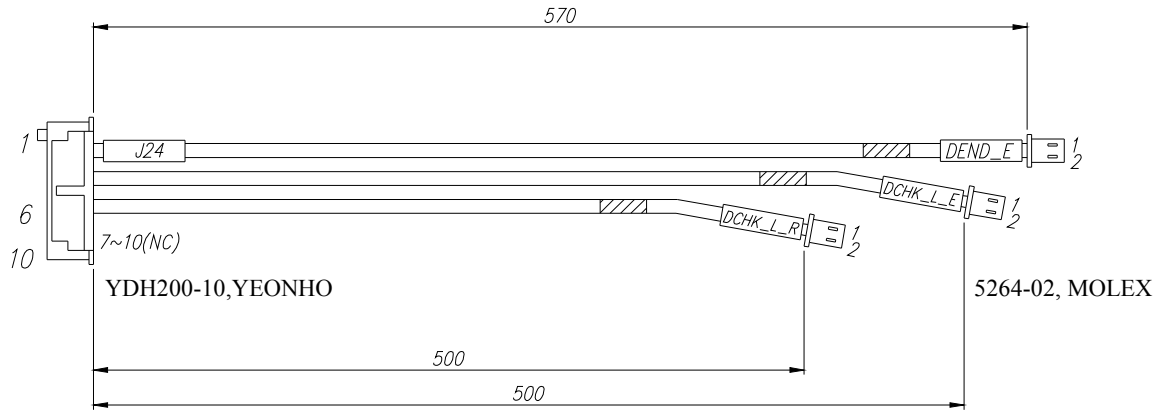

4.6.18 CLUTCH ECDM [P/N:B1212A0340]

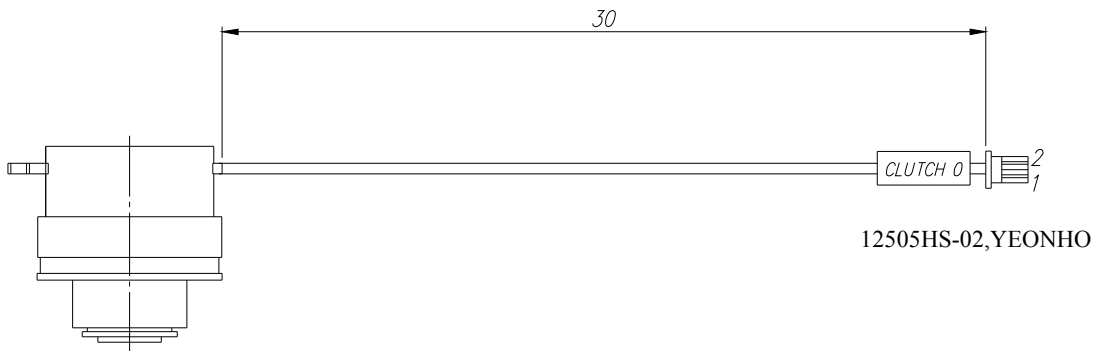

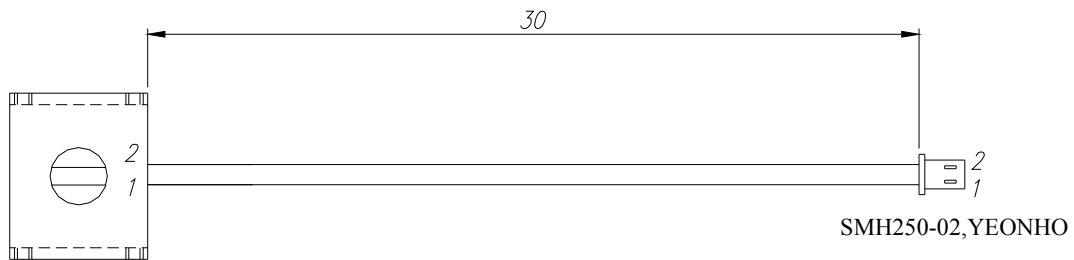

4.6.19 DIV SOLENOID ECDM [P/N:B1212A0336]

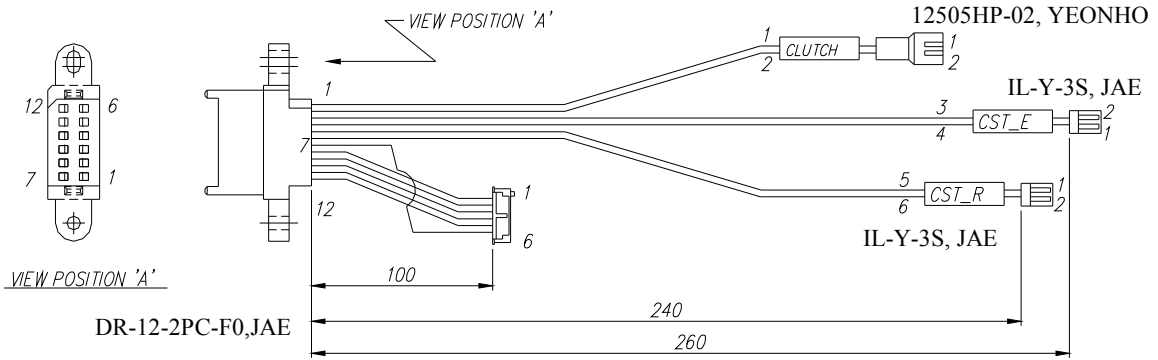

	DOC NO	MODEL	NAME	REV.	PAGE
	PL-ECDM0400-004	ECDM-400	Service Manual	1.01	37 of 65

4.6.20 CASSETTE ECDM-400 [P/N:B1212P0379]



	DOC NO	MODEL	NAME	REV.	PAGE
	PL-ECDM0400-004	ECDM-400	Service Manual	1.01	38 of 65

5 Maintenance

5.1 UNIT : Main Body

NO	Item	How to Check or Repair	Checking Point	Period (Month)	Refer.
1	ANTI-STATIC BRUSH	Checking BRUSH	Visual Status	6M	5.1-A
2	PS(SE) & TIMING BELT	Checking belts status with manual feeding by driving knob	Noise, Belt Separation	6M	
3	SOLENOID	1) Test Operaton by using TEST PROGRAM 2) Checking Linkage Operation by MANUAL	Test Operation	6M	5.1-B
4	BLDC MOTOR	Visual checking appearance of MOTOR and cable harness	Appearance	6M	5.1-C
5	RVDT Mechanism	SEN DIAG button of TEST PROGRAM shows the variance of REFERENCE value	In case of real notes, the reference value should be between 0X4C and 0X58.	6M	
6	PLATE D/D HINGE	Visual Checking	Checking Deflection	6M	5.1-D
7	PLATE CLEAN D/D ROLLER	Visual Checking	Adhesive Dust on the surface of D/D ROLLER	6M	5.1-E
8	PATH SENSOR	CLEANING with Swab	Checking Sensor Status After CLEANING	6M	5.1-F
9	CABLE & CONNECTOR	Visual Checking	Peel-off of CABLE, CONNECTOR Assembling	6M	5.1-G
10	NEAREND SENSOR	CLEANING with Swab	Checking Sensor Status After CLEANING	6M	5.1-H

	DOC NO	MODEL	NAME	REV.	PAGE
	PL-ECDM0400-004	ECDM-400	Service Manual	1.01	39 of 65

5.1-A) ANTI-STATIC BRUSH

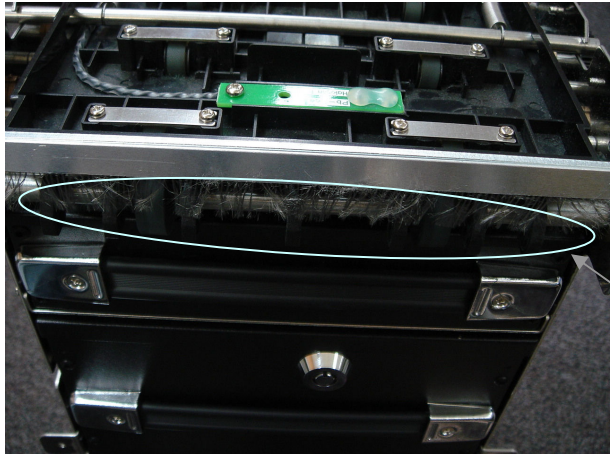

In case serious damaged BRUSH, it should be replaced with new one.

5.1-B) DIVERTING

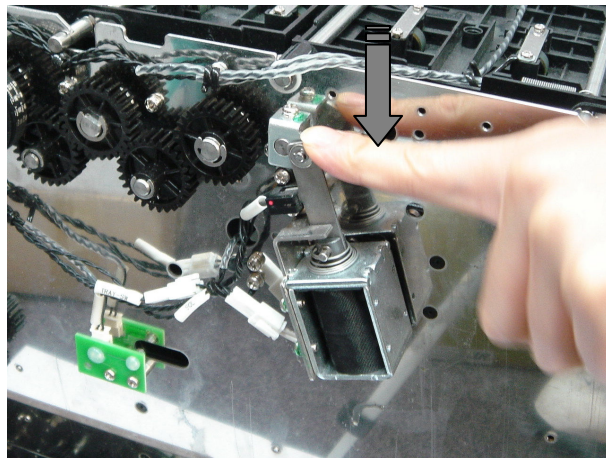
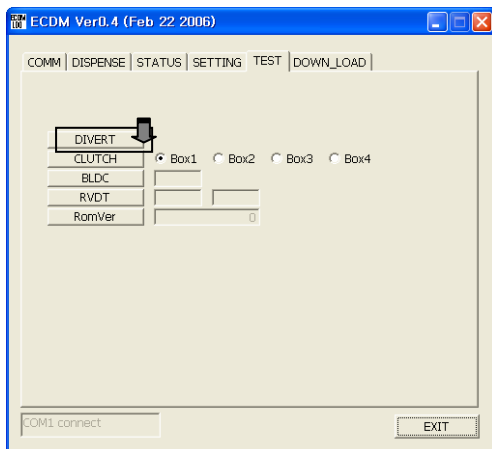

- 1) TEST PROGRAM → TEST TAB → DIVERT Button : Checking SOLENOID
- 2) In case of abnormal operation, please remove cover and push the the linkage of solenoid. Then, check whether the linkage is abnormally locked by improper parts or any reason.

	DOC NO	MODEL	NAME	REV.	PAGE
	PL-ECDM0400-004	ECDM-400	Service Manual	1.01	40 of 65

5.1-C) BLDC MOTOR

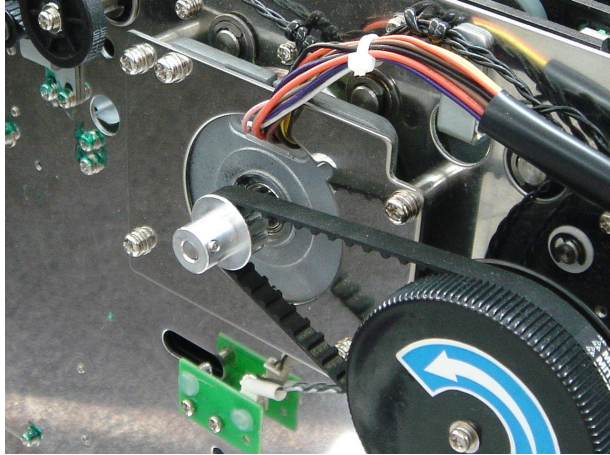

1) Please remove the cover and check MOTOR, MOTOR BRACKET and cables near MOTOR.

5.1-D) PLATE D/D HINGE

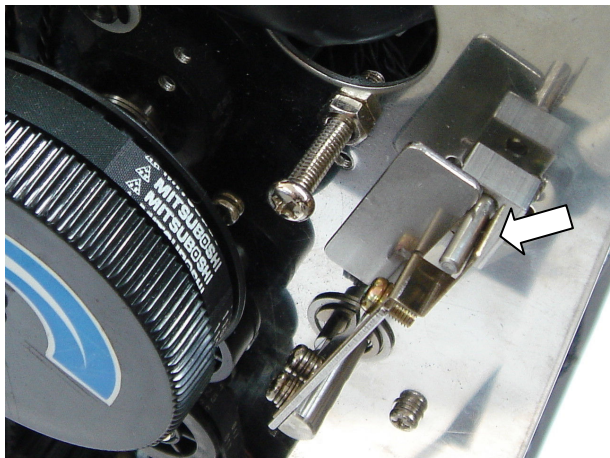

1) After removing COVER, visually check the deflection or wrong assembling of the PLATE D/D HINGE mechanism.

	DOC NO	MODEL	NAME	REV.	PAGE
	PL-ECDM0400-004	ECDM-400	Service Manual	1.01	41 of 65

5.1-E) PLATE CLEAN D/D ROLLER

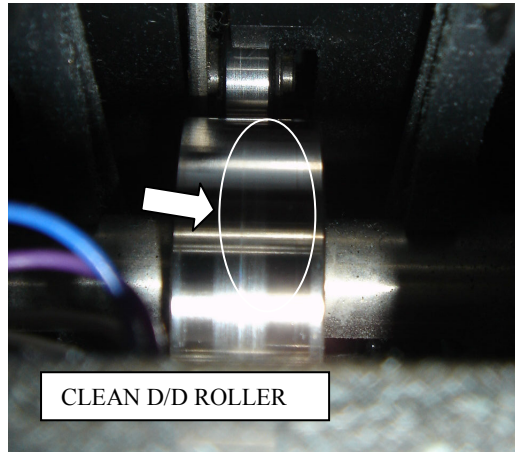
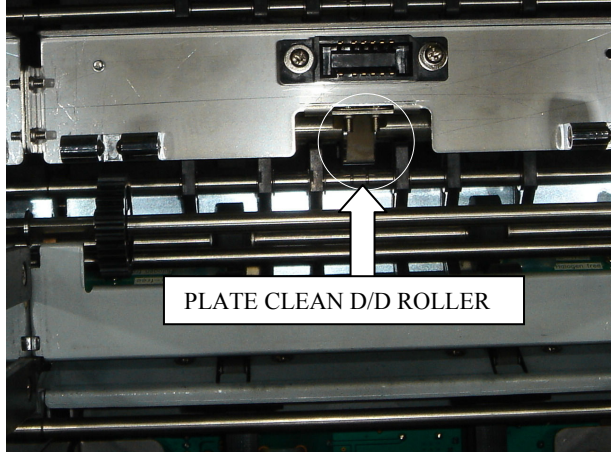

- 1) After removing the 1st High CASH CASSETTE, check the deflection of PLATE CLEAN D/D ROLLER.
- 2) After removing GUIDE ASSY CASH FEED 7 EJT, check the surface of PLATE CLEAN D/D ROLLER and D/D ROLLER. If there is dust, please clean that by swab.

5.1-F) PATH SENSOR

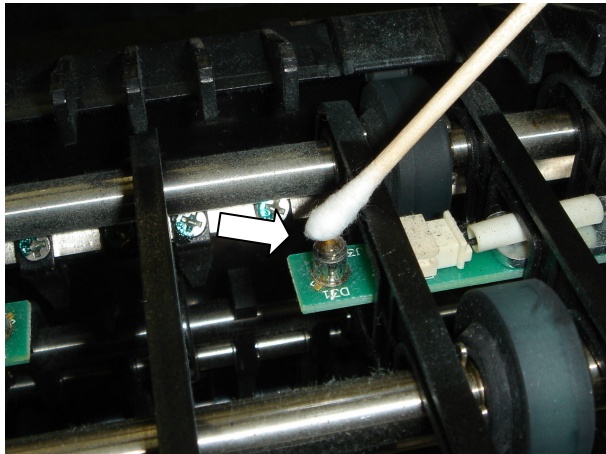

- 1) After opening GUIDE, the surface of the sensors should be cleared by swab.

	DOC NO	MODEL	NAME	REV.	PAGE
	PL-ECDM0400-004	ECDM-400	Service Manual	1.01	42 of 65

5.1-G) CABLE & CONNECTOR

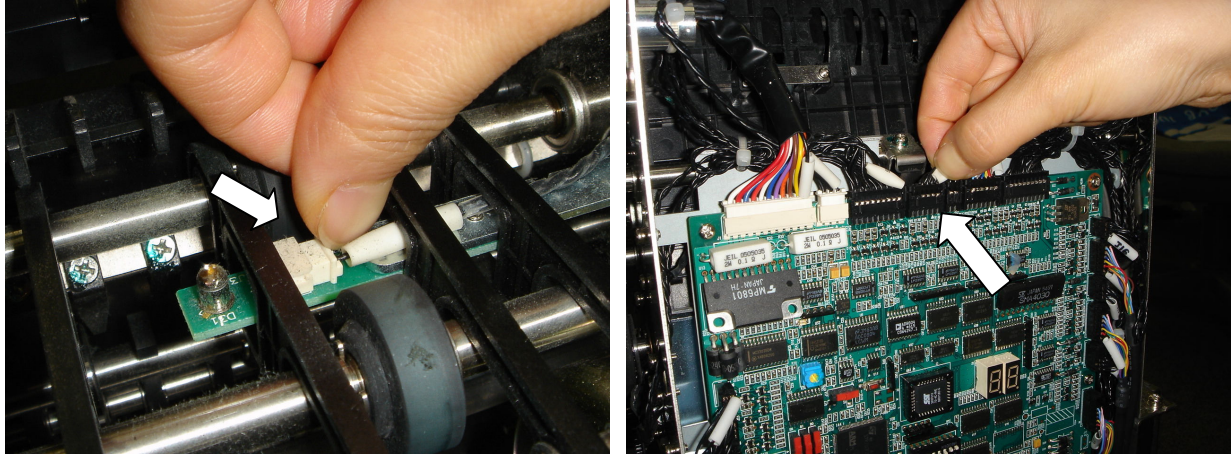

- 1) Check SENSOR PWA CONNECTOR.
- 2) Check CONNECOTR of MAIN PWA.

5.1-H) NEAREND SENSOR

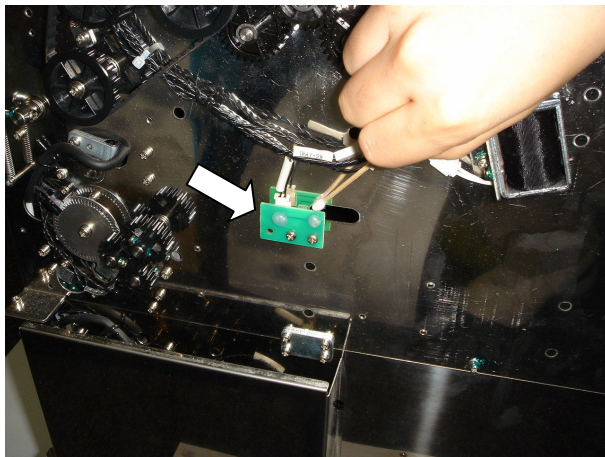

- 1) After removing COVER, NEAREND SENSOR should be cleaned by swab.
- 2) Both sides of NEAREND SENSOR should be cleaned.

	DOC NO	MODEL	NAME	REV.	PAGE
	PL-ECDM0400-004	ECDM-400	Service Manual	1.01	43 of 65

5.2 UNIT : Cash Cassette

NO	Item	How to Check or Repair	Checking Point	Period (Month)	Refer.
1	PICKUP ROLLER	Clean the surface of Rubber by clothing		6M	5.2-A
2	RUBBER PICKUP PLATE	Visual Checking		6M	5.2-B
3	CB SENSOR	CLEANING by swab	Checking Sensor Status After CLEANING	6M	5.2-C
4	Pushing Plate LOCK	Checking MANUAL LOCK	Checking damage	6M	5.2-D
5	KEY LOCK	Manual Checking	Checking damage	6M	5.2-E

5.2-A) PICKUP ROLLER

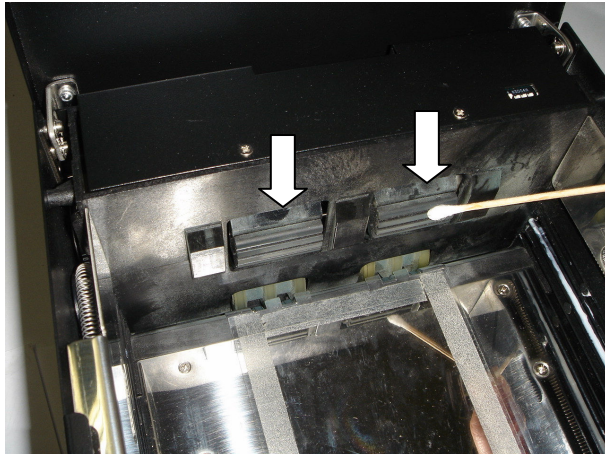

1) Remove dust from Rubber of PICKUP ROLLER by swab or clothings.

	DOC NO	MODEL	NAME	REV.	PAGE
	PL-ECDM0400-004	ECDM-400	Service Manual	1.01	44 of 65

5.2-B) RUBBER PICKUP PLATE

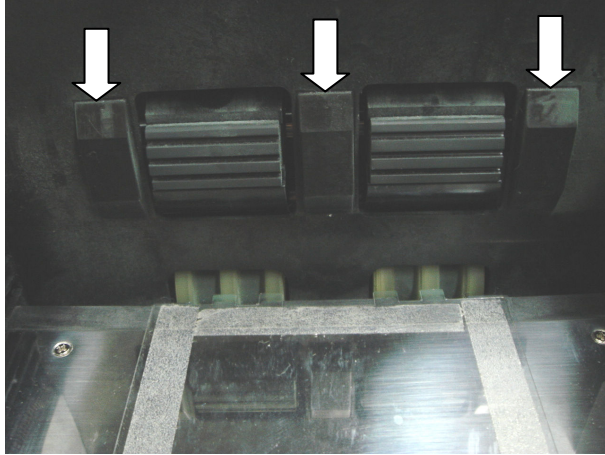

1) Check if PICKUP PLATE is attached normal or detached.

5.2-C) CB SENSOR

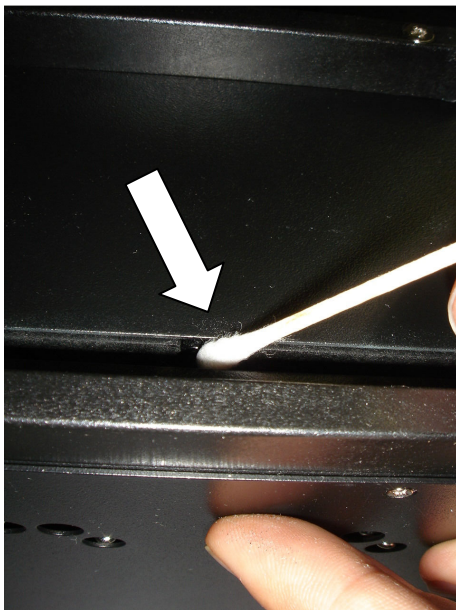

1) CB SENSOR on the outlet of CASH CASSETTE should be cleaned by swab.

	DOC NO	MODEL	NAME	REV.	PAGE
	PL-ECDM0400-004	ECDM-400	Service Manual	1.01	45 of 65

5.2-D) Pushing Plate LOCK

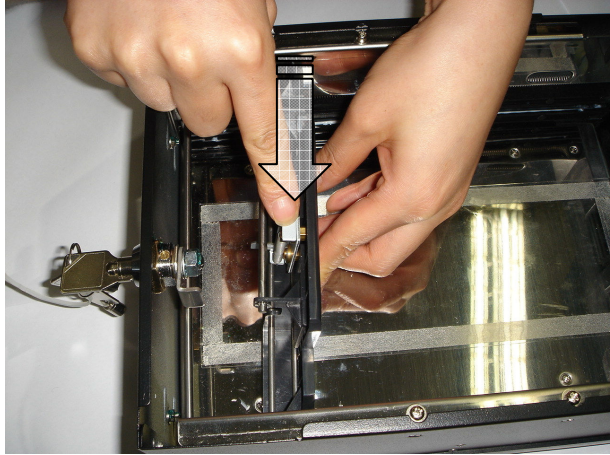

1) Check if locking mechanism of pushing plate is operated well.

5.2-E) KEY LOCK

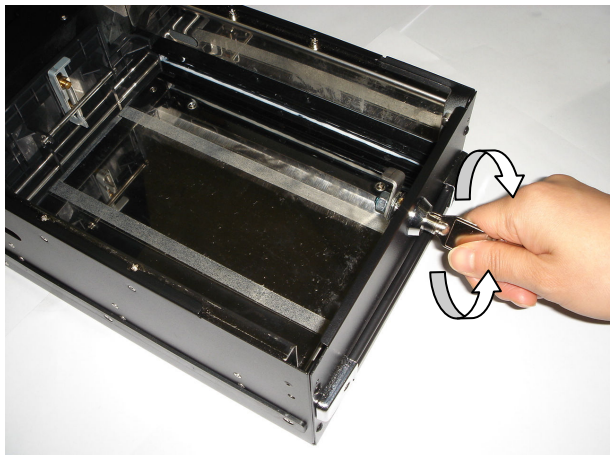

1) Through manual locking and unlocking, check if the key is operated well or not.

	DOC NO	MODEL	NAME	REV.	PAGE
	PL-ECDM0400-004	ECDM-400	Service Manual	1.01	46 of 65

5.3 UNIT : Reject Cassette

NO	Item	How to Check or Repair	Checking Point	Period (Month)	Refer.
1	ANTI-STATIC BRUSH	Checking BRUSH Status	Checking Damage	6M	5.3-A
2	ONEWAY BEARING	Checking Oneway Roller Status by Manually Driving Feeding Gear		6M	5.3-B
3	FILM REJECT BOX	Checking Attachment Visually		6M	5.3-C
4	KEY LOCK	Manual Checking	Checking Damage	6M	5.3-D

5.3-A) ANTI-STATIC BRUSH

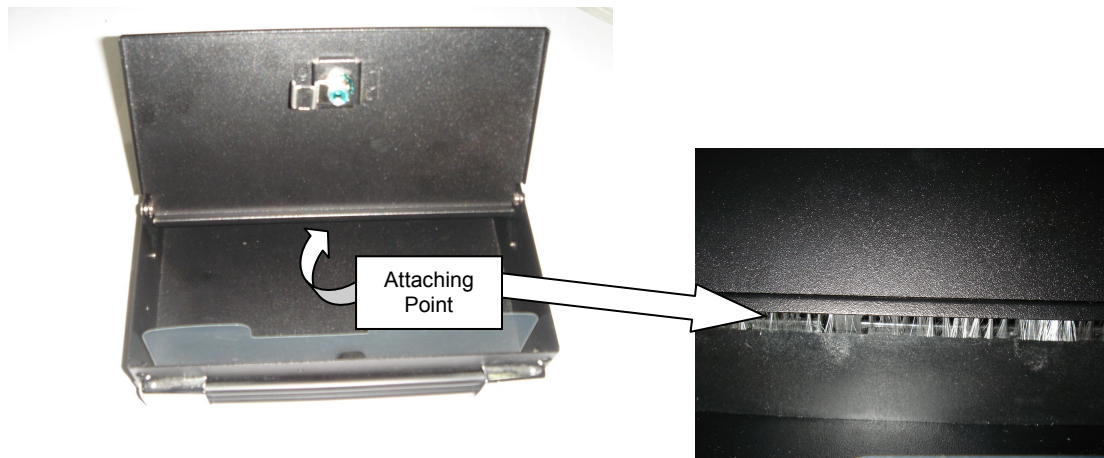

1) Open cover and check the status of Anti-Static Brush.

	DOC NO	MODEL	NAME	REV.	PAGE
	PL-ECDM0400-004	ECDM-400	Service Manual	1.01	47 of 65

5.3-B) ONEWAY BEARING

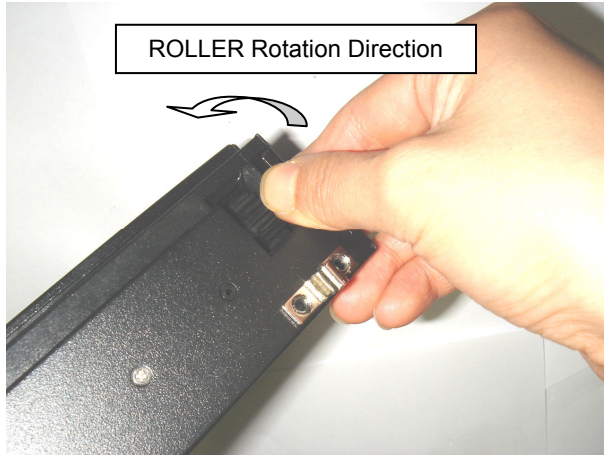

1) Check if the roller of SHAFT ASSY REJECT is operated well by manual driving the gear.

5.3-C) FILM REJECT BOX



1) After opening COVER, check the position and angle (normal to bottom) of film.

	DOC NO	MODEL	NAME	REV.	PAGE
	PL-ECDM0400-004	ECDM-400	Service Manual	1.01	48 of 65

5.3-D) KEY LOCK

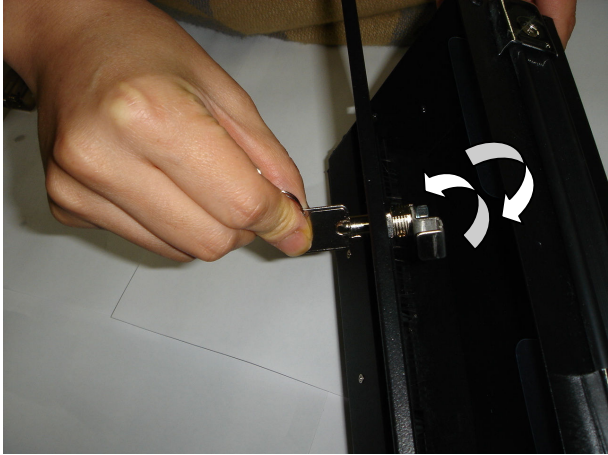

1) Through manual locking and unlocking, check if the key is operated well or not.

	DOC NO	MODEL	NAME	REV.	PAGE
	PL-ECDM0400-004	ECDM-400	Service Manual	1.01	49 of 65

6 TROUBLE SHOOTING – ERROR CODES

The trouble shooting process of ECDM for each trouble is like the below.

6.1 Note Jam

Trouble	Jamming Between CHK SENSOR and RVST SENSOR
Error Code	0x01
Checking Points	<ol style="list-style-type: none"> 1. Is CONNECTOR (J6, J9) and CABLE connected properly? 2. Is there any stuff on the path related to PS(SE) BELT FEEDING? 3. Is RVDT SENSOR okay?
Action	After checking, remove all the stuff on the path by manual driving Knob.

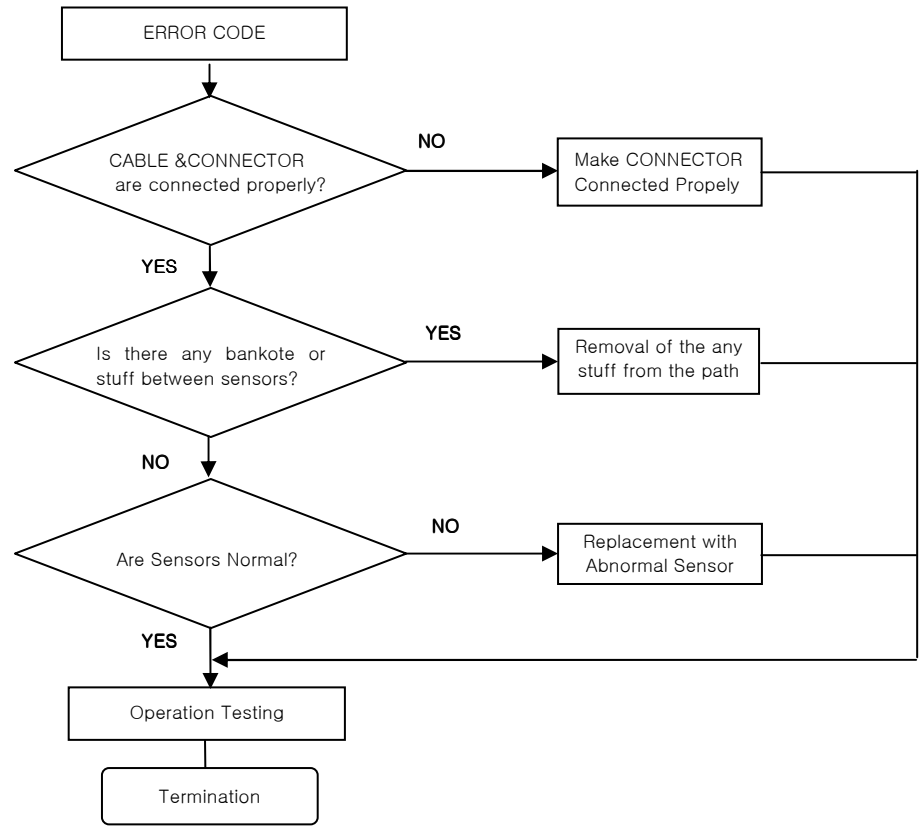

```

graph TD
    Start[ERROR CODE] --> D1{CABLE & CONNECTOR  
are connected properly?}
    D1 -- NO --> A1[Make CONNECTOR  
Connected Propely]
    D1 -- YES --> D2{Is there any bankote or  
stuff between sensors?}
    D2 -- YES --> A2[Removal of the any  
stuff from the path]
    D2 -- NO --> D3{Are Sensors Normal?}
    D3 -- YES --> OT[Operation Testing]
    D3 -- NO --> A3[Replacement with  
Abnormal Sensor]
    A1 --> OT
    A2 --> OT
    A3 --> OT
    OT --> T[Termination]
  
```

	DOC NO	MODEL	NAME	REV.	PAGE
	PL-ECDM0400-004	ECDM-400	Service Manual	1.01	50 of 65

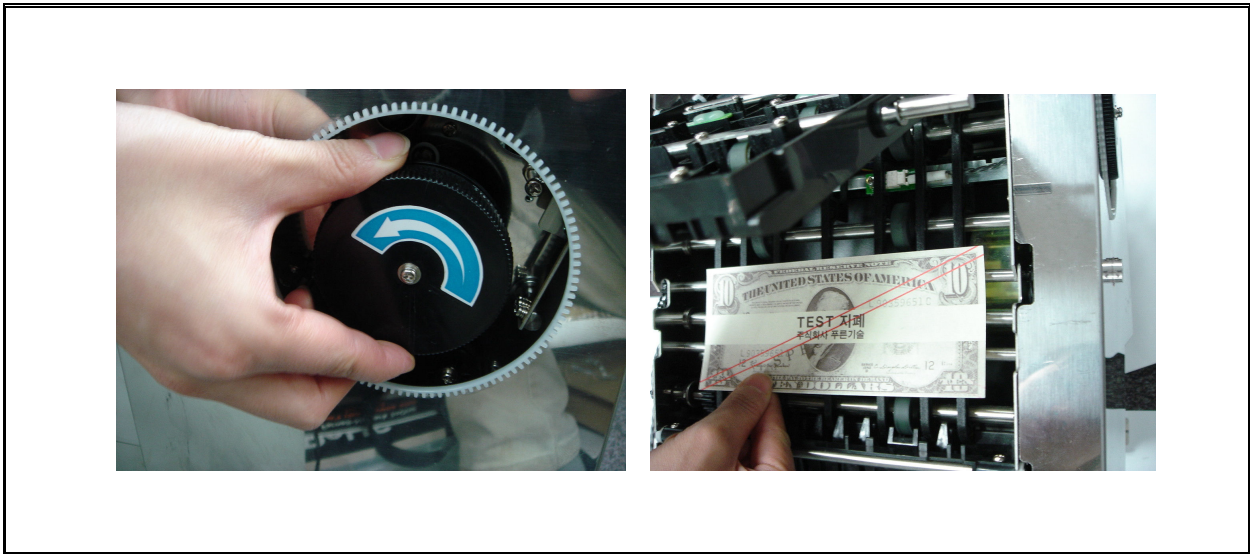

	DOC NO	MODEL	NAME	REV.	PAGE
	PL-ECDM0400-004	ECDM-400	Service Manual	1.01	51 of 65

Trouble	Jam between RVST SENSOR and DVT SENSOR
Error Code	0x02
Checking Points	<ol style="list-style-type: none"> 1. Is CONNECTOR (J6, J9) and CABLE connected properly? 2. Is there any stuff between DIV SENSOR and EJT SENSOR? 3. Is the position of DIVERT normal?
Action	After checking, remove all the stuff on the path by manual driving Knob.

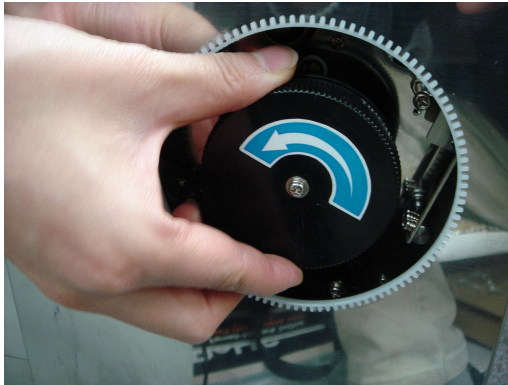

	DOC NO	MODEL	NAME	REV.	PAGE
	PL-ECDM0400-004	ECDM-400	Service Manual	1.01	52 of 65

Trouble	Jam between DVT SENSOR and EJT SENSOR
Error Code	0x03
Checking Points	<ol style="list-style-type: none"> 1. Is CONNECTOR (J6, J9) and CABLE connected properly? 2. Is there any stuff between DIV SENSOR and EJT SENSOR? 3. Is the position of DIVERT normal? 4. Is GUIDE ASSY CASH FEED 7 DIV fixed properly? 5. Is IDLE ROLLER of GUIDE ASSY CASH FEED 7 DIV normal? 6. Is EJT SENSOR normal?
Action	After checking, remove all the stuff on the path by manual driving Knob.

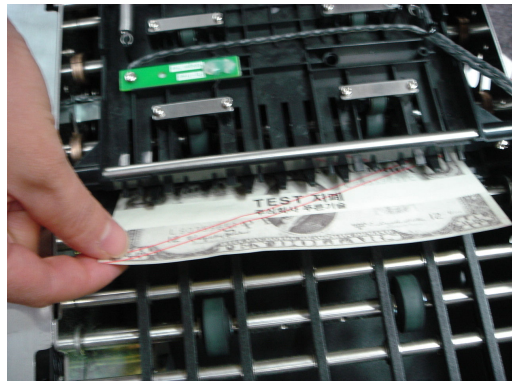
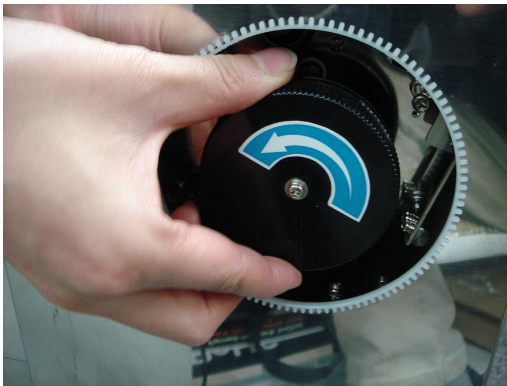

	DOC NO	MODEL	NAME	REV.	PAGE
	PL-ECDM0400-004	ECDM-400	Service Manual	1.01	53 of 65

Trouble	Jam between EJT SENSOR and EXT SENSOR
Error Code	0x04, 0x09
Checking Points	<ol style="list-style-type: none"> 1. Is CONNECTOR (J6, J9) and CABLE connected properly? 2. Is there any stuff between EJT SENSOR and EXT SENSOR? 3. Is GUIDE ASSY CASH FEED 7 DIV fixed properly? 4. Is IDLE ROLLER of GUIDE ASSY CASH FEED 7 DIV normal? 5. Is EJT SENSOR normal?
Action	After checking, remove all the stuff on the path by manual driving Knob.

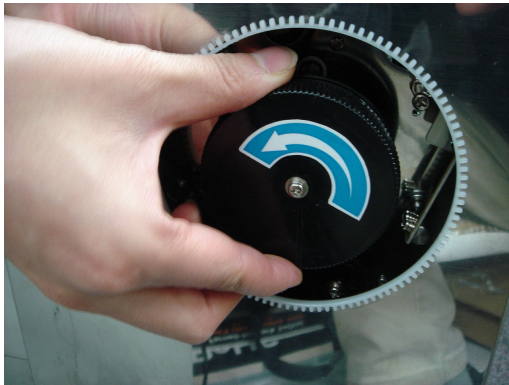

	DOC NO	MODEL	NAME	REV.	PAGE
	PL-ECDM0400-004	ECDM-400	Service Manual	1.01	54 of 65

Trouble	EXT SENSOR JAM
Error Code	0x05, 0x0A
Checking Points	<ol style="list-style-type: none"> 1. Is CONNECTOR (J6, J9) and CABLE connected properly? 2. Is there stuff between EXT SENSOR and exit? 3. Is GUIDE ASSY CASH FEED 7 EJT fixed properly? 4. Is IDLE ROLLER of GUIDE ASSY CASH FEED 7 EJT normal? 5. Is EXT SENSOR normal?
Action	After checking, remove all the stuff on the path by manual driving Knob.

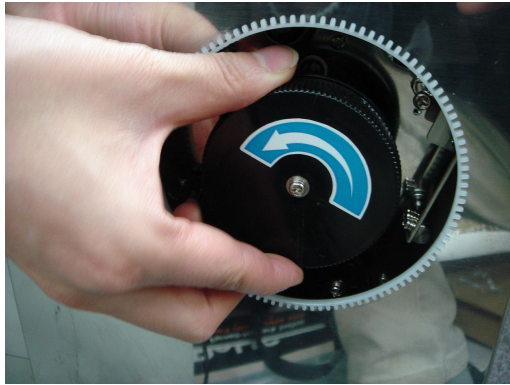

	DOC NO	MODEL	NAME	REV.	PAGE
	PL-ECDM0400-004	ECDM-400	Service Manual	1.01	55 of 65

6.2 Diverting Error

Trouble	DIVERTER Operation Error
Error Code	0x06, 0x0E, 0x10
Checking Points	<ol style="list-style-type: none"> 1. Is SOLENOID CONNECTOR(J7) connected properly? 2. Is SOLENOID operated well by test program? 3. Is CONNECTOR (J6, J9) and CABLE connected properly? 4. Is SOLENOID INTERRUPT SENSOR, DIV SENSOR and EJT SENSOR are okay? 5. Is there any stuff between DIV SENSOR and EJT SENSOR?
Action	After clearing error, recheck normal operation.

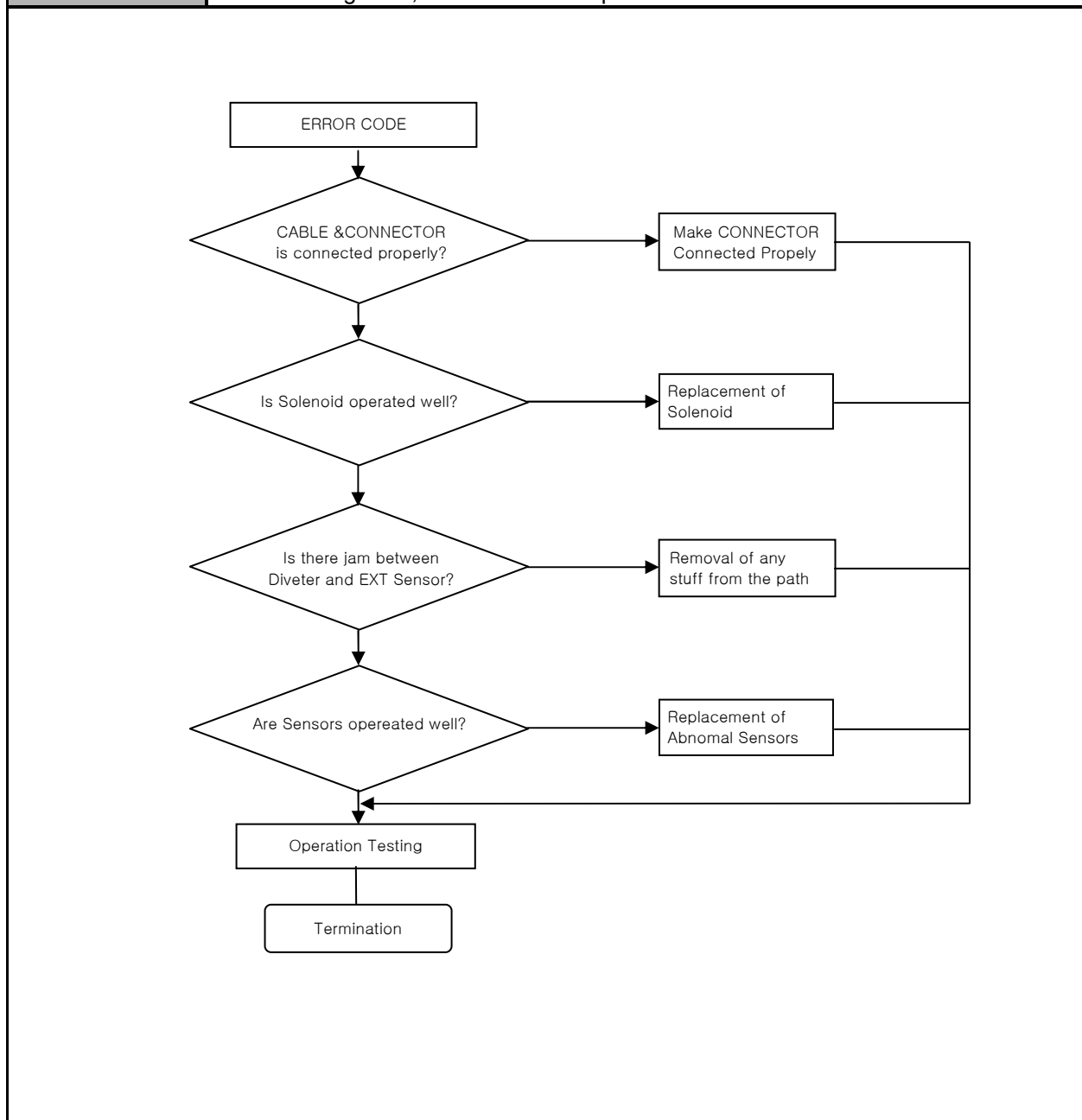

	DOC NO	MODEL	NAME	REV.	PAGE
	PL-ECDM0400-004	ECDM-400	Service Manual	1.01	56 of 65

6.3 Sensor Error

Trouble	Sensor Error
Error Code	0x13, 0x20 ~ 0x4F
Checking Points	<ol style="list-style-type: none"> Are CONNECTOR & CABLE connected propely? (Refer to PWA Structure Fig) Is there any banknote or stuff on the path? Is each SENSOR normal?
Action	After clearing error, recheck normal operation.

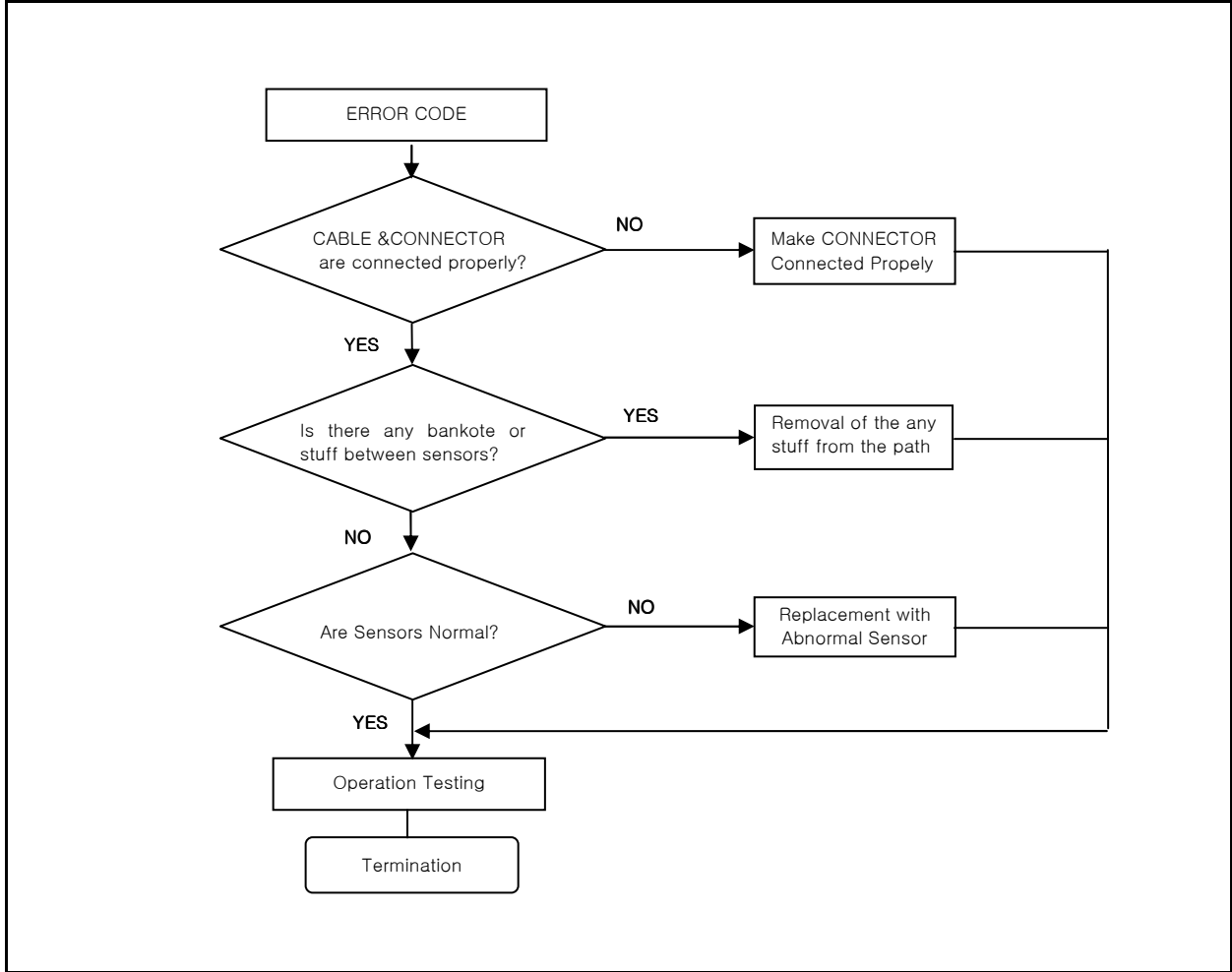

	DOC NO	MODEL	NAME	REV.	PAGE
	PL-ECDM0400-004	ECDM-400	Service Manual	1.01	57 of 65

6.4 Motor Speed Down

Trouble	Too Late Motor Speed
Error Code	0x11
Checking Points	<ol style="list-style-type: none"> 1. Is there any stuff at the power transmission? 2. Are WHEEL SENSOR CONNECTOR(J20) and CABLE connected properly? 3. Is WHEEL SENSOR normal? 4. Is WHEEL assembled properly? 5. Is there any stuff on PATH and CASH CASSETTE?
Action	After clearing error, recheck normal operation.

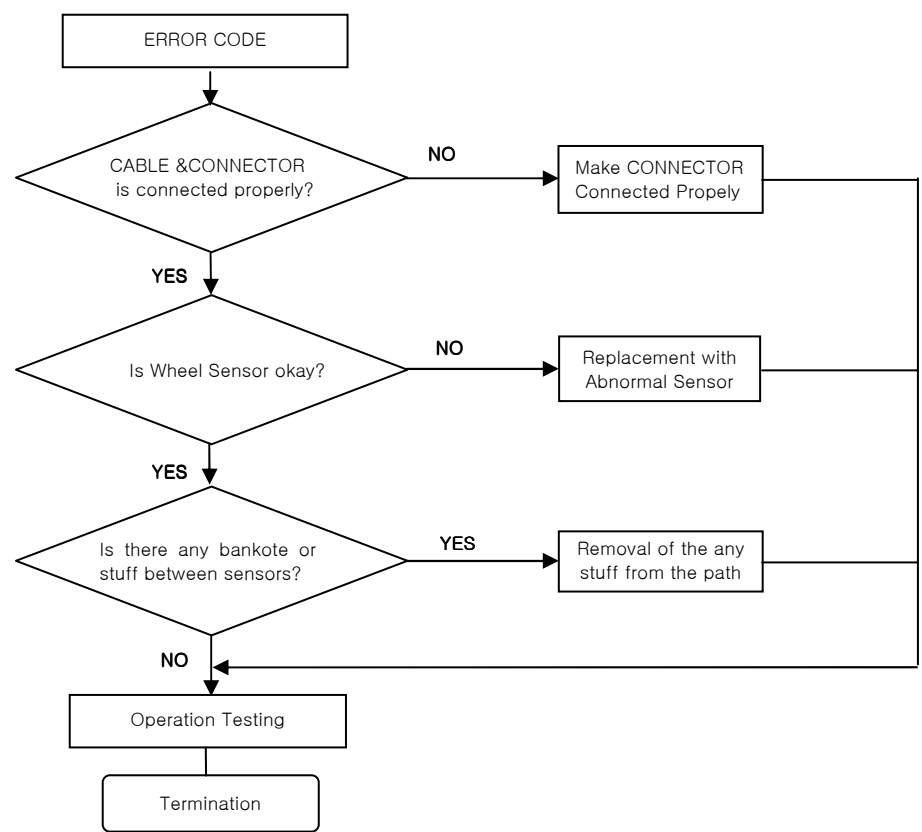

```

graph TD
    Start[ERROR CODE] --> D1{CABLE & CONNECTOR is connected properly?}
    D1 -- NO --> A1[Make CONNECTOR Connected Propely]
    D1 -- YES --> D2{Is Wheel Sensor okay?}
    D2 -- NO --> A2[Replacement with Abnormal Sensor]
    D2 -- YES --> D3{Is there any bankote or stuff between sensors?}
    D3 -- YES --> A3[Removal of the any stuff from the path]
    D3 -- NO --> OT[Operation Testing]
    A1 --> OT
    A2 --> OT
    A3 --> OT
    OT --> T[Termination]
  
```

	DOC NO	MODEL	NAME	REV.	PAGE
	PL-ECDM0400-004	ECDM-400	Service Manual	1.01	58 of 65

6.5 Cash Cassette Error

Trouble	1. Not Detect Cash Cassette 2. Different Type of Main Board from Type of Cash Cassette 3. No Cash Cassette with Type Requested by User
Error Code	1. 0x58, 0x59, 0x5A, 0x5B (Not Detect Cash Cassette) 2. 0x64, 0x65, 0x66, 0x67 (Different Type) 3. 0x68, 0x69, 0x6A, 0x6B (No Cash Cassette with Requested Type)
Checking Points	1. Is Cash Cassette inserted properly? 2. Are CASSETTE CONNECTOR and CABLE connected properly? (The 1 st High : J8, The 2 nd High : J11, The 3 rd High : J21, The 4 th high : J22) 3. Are Dip switches of Cash Cassette set properly?
Action	After clearing error, recheck normal operation.

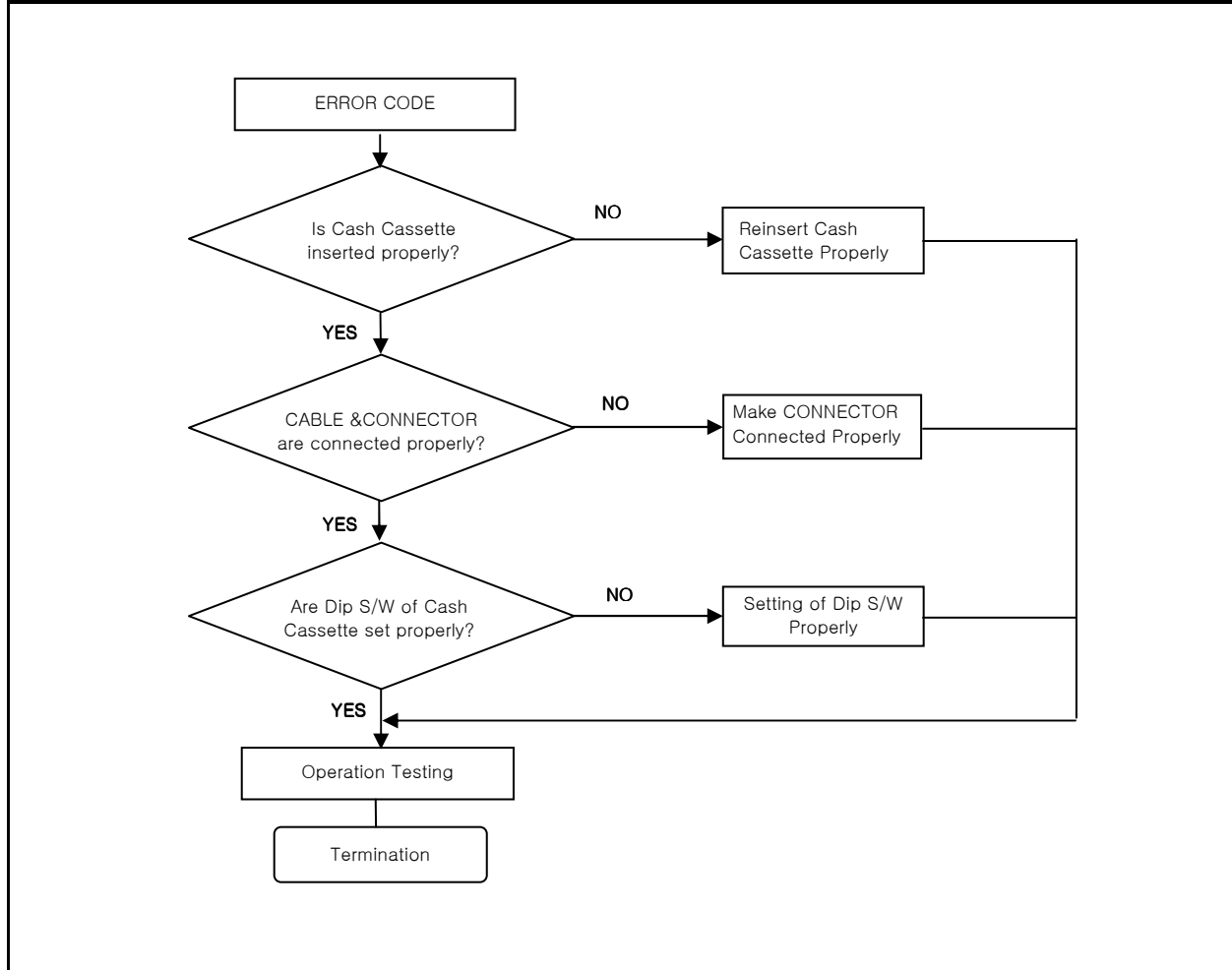

	DOC NO	MODEL	NAME	REV.	PAGE
	PL-ECDM0400-004	ECDM-400	Service Manual	1.01	59 of 65

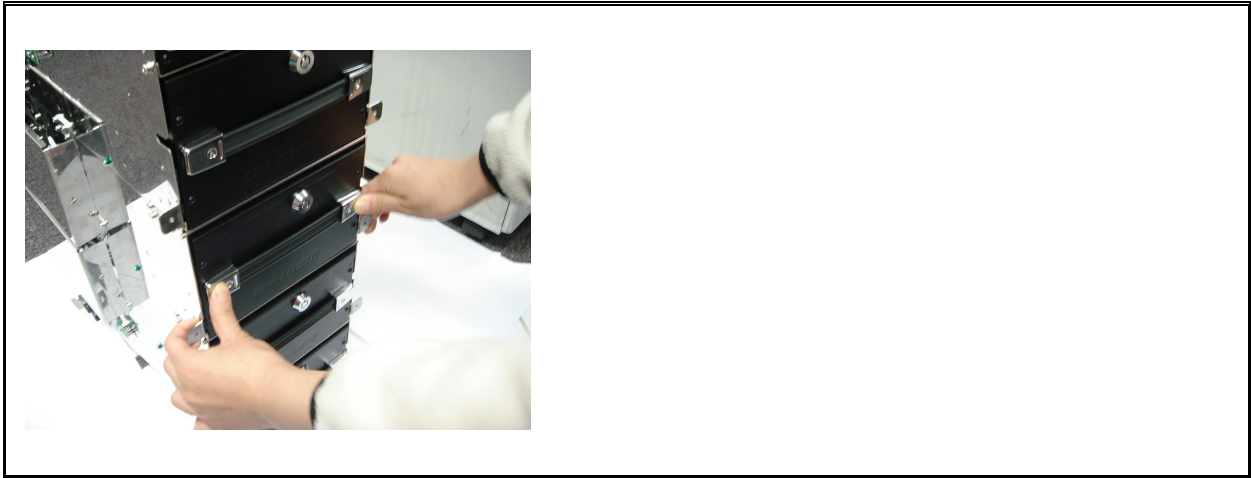

	DOC NO	MODEL	NAME	REV.	PAGE
	PL-ECDM0400-004	ECDM-400	Service Manual	1.01	60 of 65

6.6 Reject Cassette Error

Trouble	No Detection of Reject Cassette
Error Code	0x12
Checking Points	<ol style="list-style-type: none"> 1. Is the REJECT CASSETTE inserted on the normal position? 2. Are REJECT CASSETTE CONNECTOR(J7) and CABLE connected properly?
Action	After clearing error, recheck normal operation.

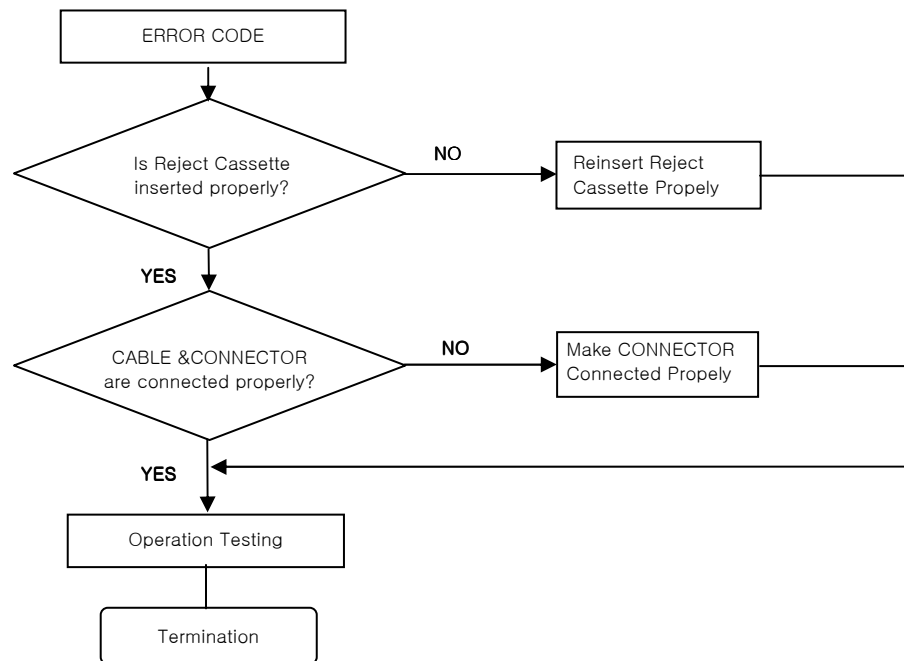

	DOC NO	MODEL	NAME	REV.	PAGE
	PL-ECDM0400-004	ECDM-400	Service Manual	1.01	61 of 65

6.7 Abnormal Pick-up Operation

Trouble	Abnormal Pickup Operation in the Cash Cassette
Error Code	0x51, 0x52, 0x53, 0x60, 0x61, 0x62, 0x63
Checking Points	<ol style="list-style-type: none"> 1. Is Cash Cassette inserted properly? 2. Are CASSETTE CONNECTOR and CABLE connected properly? (The 1st High : J8, The 2nd High : J11, The 3rd High : J21, The 4th High : J22) 3. Is there any jam in the Cash Cassette? 4. Are all the banknotes dispensed from Cash Cassette? 5. Are banknotes loaded properly into Cash Cassette? 6. Is Pusher in the Cash Cassette slided well?
Action	<ol style="list-style-type: none"> 1. After Checking, Insert Cash Cassette into Main Body. 2. When all the notes are dispensed, NEAREND SENSOR should be checked.

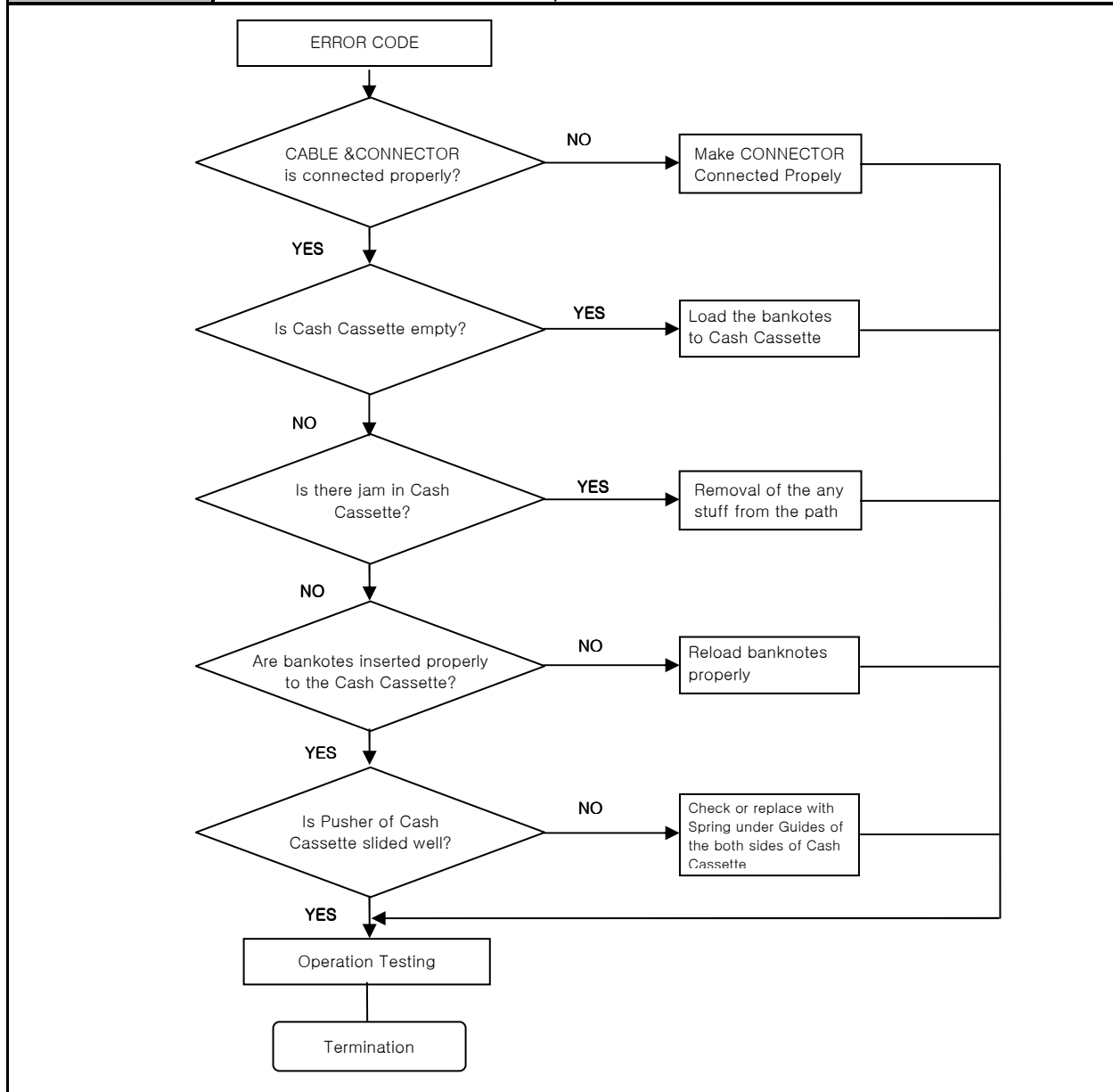

	DOC NO	MODEL	NAME	REV.	PAGE
	PL-ECDM0400-004	ECDM-400	Service Manual	1.01	62 of 65

6.8 Jam in Cash Cassette

Trouble	Detecting Banknotes on Pick-up Path of Cash Cassette
Error Code	0x54, 0x55, 0x56, 0x57
Checking Points	<ol style="list-style-type: none"> Are CASSETTE CONNECTOR and CABLE connected properly? (The 1st High : J8, The 2nd High : J11, The 3rd High : J21, The 4th High : J22) Is there any stuff on PICKUP PATH of Cash Cassette? Is CB SENSOR normal?
Action	After clearing error, recheck normal operation.

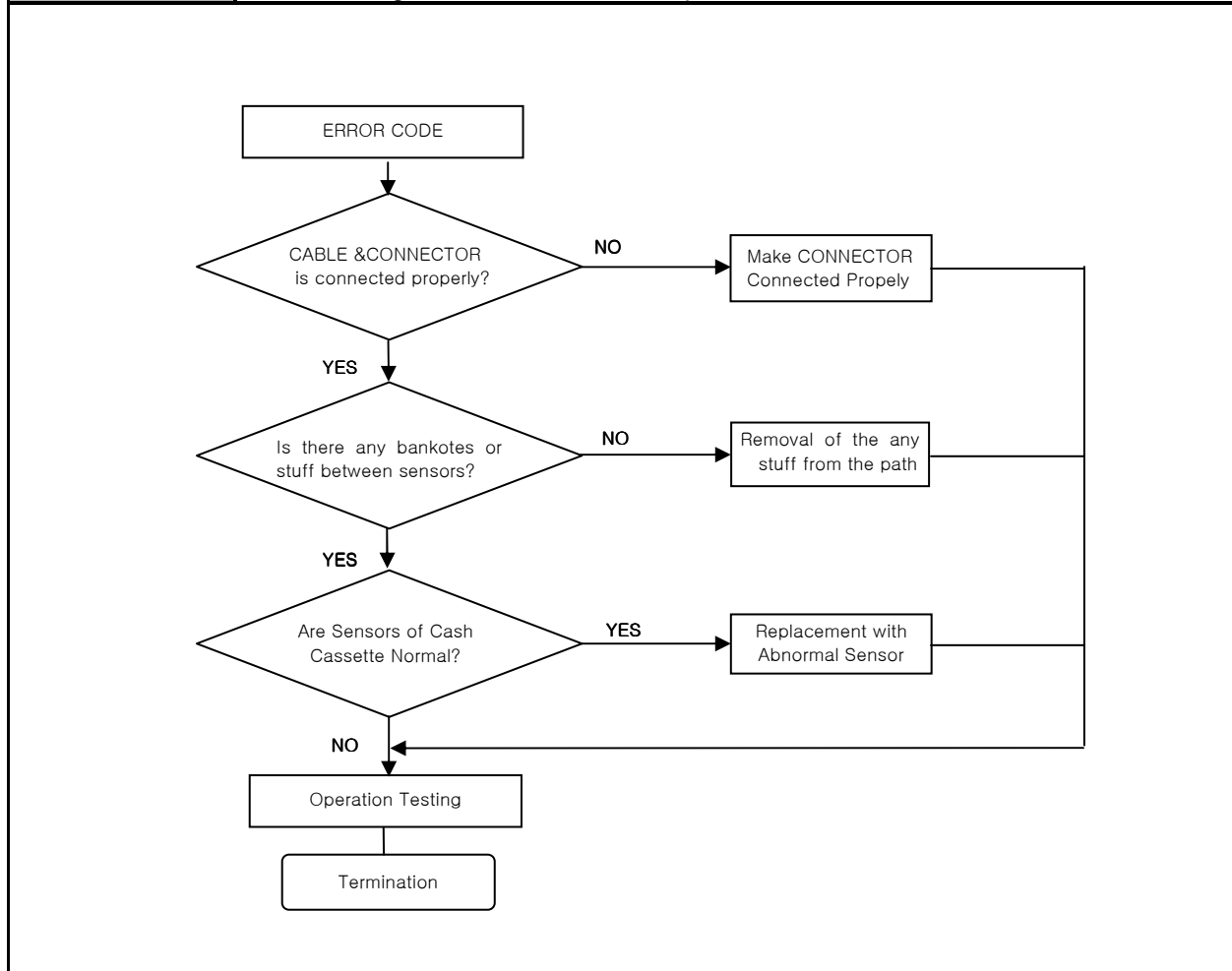

	DOC NO	MODEL	NAME	REV.	PAGE
	PL-ECDM0400-004	ECDM-400	Service Manual	1.01	63 of 65

6.9 Over Reject

Trouble	More than 20 Banknotes Are Rejected During Transaction.
Error Code	0x0D
Checking Points	<ol style="list-style-type: none"> 1. Is the banknotes loaded properly inside Cash Cassette? 2. Is RVDT SENSOR normal? 3. Is CHK SENSOR(L/R) normal? 4. Is the definition of banknotes like thickness and length set to the loaded notes? 5. Is the clutch of Cash Cassette normal? 6. Is Oneway Roller of Cash Cassette operated normally?
Action	<ol style="list-style-type: none"> 1. Check the parameter values using SEN DIAG command of TEST PROGRAM. 2. Check the operational status after testing.

	DOC NO	MODEL	NAME	REV.	PAGE
	PL-ECDM0400-004	ECDM-400	Service Manual	1.01	64 of 65

7 SPARE PART LIST

7.1 UNIT ECDM-400 Mechaimsm

NO	PART NO	DESCRIPTION	SPECIFICATION	PCS/SET
1	B1104P0021	BELT	TIMING 108XL BANDO(W:6.4)	1
2	B1104P0025	BELT	PS 140 (W:10)	6
3	B1104P0026	BELT	PS 197 (W:10)	6
4	B1104P0095	BELT	TIMING 120XL BANDO(W:6.4)	3
5	B1104P0097	BELT	TIMING 87MXL BANDO(W:4.8)	1
6	B1104P0098	BELT	TIMING 128XL BANDO(W:6.4)	1
7	B1104P0101	BELT	TIMING 84XL (W:6.4)	3
8	B1104P0103	BELT	TIMMING 116XL(W:6.4)	1
9	B1110P0002	BRUSH	LCDM-1000	1
10	B1111P0021	BUSH	1060 LCDM	8
11	B1212A0339	CABLE ASSY	LIMIT SWITCH ECDM	1
12	B1212A0341	CABLE ASSY	SOLENOID/SOL SENSOR ECDM	1
13	B1212A0345	CABLE ASSY	RVDT ECDM	1
14	B1212A0346	CABLE ASSY	WHEEL SENSOR ECDM	1
15	B1212A0365	CABLE ASSY	MOTOR FB801D ECDM-200	1
16	B1212A0371	CABLE ASSY	CST CONNECTION ECDM PART B	1
17	B1212A0372	CABLE ASSY	CST CONNECTION ECDM PART C	1
18	B1212A0373	CABLE ASSY	CST CONNECTION ECDM PART D	1
19	B1212A0380	CABLE ASSY	CST CONNECTION ECDM PART A	1
20	B1212P0343	CABLE	SENSOR PATH L ECDM	1
21	B1212P0344	CABLE	SENSOR PATH R ECDM	1
22	B1212P0362	CABLE	PATH L ECDM-200	1
23	B1212P0374	CABLE	PATH R ECDM PART B	1
24	B1212P0375	CABLE	PATH R ECDM PART C	1
25	B1212P0376	CABLE	PATH R ECDM PART D	1
26	B1212P0377	CABLE	PATH L ECDM PART C	1
27	B1212P0378	CABLE	PATH L ECDM PART D	1
28	B1502P0001	FOOT	SQUARE(14X14) ECDM	2
29	B1604P0297	GUIDE	CASH FEED7 ECDM	2
30	B2806P0020	SOLENOID	MSS-1040 J08A ECDM (RoHS)	1
31	RPA000006B	PWA,ROHS	LCDM SENSOR PCB EMIT	14
32	RPA000007B	PWA,ROHS	LCDM SENSOR PCB RCV	14
33	RPA000037B	PWA,ROHS	ECDM-100 NEAREND RCV SEN	4
34	RPA000037C	PWA,ROHS	ECDM-100 NEAREND EMIT SEN	4
35	RPA000041A	PWA,ROHS	ECDM-400 MAIN V1.0	1
36	B3001A0138	UNIT	REJECT CASSETTE (ECDM)	1
37	B3001A0171	UNIT	CASH CASSETTE (ECDM-400 USD)	4
38	B3001A0172	UNIT	CASH CASSETTE (ECDM-400 EUR)	4

	DOC NO	MODEL	NAME	REV.	PAGE
	PL-ECDM0400-004	ECDM-400	Service Manual	1.01	65 of 65

7.2 UNIT Cash Cassette

NO	PART NO	DESCRIPTION	SPECIFICATION	PCS/SET
1	B1104P0016	BELT	TIMING 56MXL BANDO(W:3.2)	1
2	B1104P0096	BELT	TIMING 64XL BANDO(W:3.2)	1
3	B1205P0008	CLUTCH	EL24PL ECDM	1
4	B1212A0379	CABLE ASSY	CASSETTE ECDM-400	1
5	B1217P0010	CAM	KEY ECDM	1
6	B1501P0015	FILM	CASSETTE SLIDE ECDM	1
7	B2001P0014	KEY	C805*S	1
8	B2803A0476	SHAFT ASSY	PICKUP ROLLER ASSY ECDM	1
9	RPA000041B	PWA,ROHS	ECDM-400 BOX ID CHECK DIPSW	1

7.3 UNIT Reject Cassette

NO	PART NO	DESCRIPTION	SPECIFICATION	PCS/SET
1	B1110P0008	BRUSH	REJECT	1
2	B1501P0018	FILM	REJECTBOX	1
3	B2001P0013	KEY	CD303S	1