	<b>DOC NO</b>	<b>MODEL</b>	<b>NAME</b>	<b>REV.</b>	<b>PAGE</b>
	PL-ECDM-400-02	ECDM-400	Product Specification	1.0	1 of 11

# Product Specification

MODEL : ECDM-400  
REV. : 1.0  
DATE : 2006. 11. 1



**PULOON Technology Inc.**

	<b>DOC NO</b>	<b>MODEL</b>	<b>NAME</b>	<b>REV.</b>	<b>PAGE</b>
	PL-ECDM-400-02	ECDM-400	Product Specification	1.0	2 of 11

## Revision History

Ver.	DATE	Item		Name
		Title	Details	
1.0	2006.11.1	First Released		S. M. SONG

	<b>DOC NO</b>	<b>MODEL</b>	<b>NAME</b>	<b>REV.</b>	<b>PAGE</b>
	PL-ECDM-400-02	ECDM-400	Product Specification	1.0	3 of 11

# Contents

<b>1</b>	<b>Preview and Features .....</b>	<b>4</b>
1.1	Preview .....	4
1.2	Features .....	4
<b>2</b>	<b>Specifications .....</b>	<b>5</b>
2.1	General Specifications .....	5
2.2	Electrical Features .....	5
2.3	Operation Environment .....	5
<b>3</b>	<b>Layout .....</b>	<b>6</b>
<b>4</b>	<b>Connector Specifications .....</b>	<b>7</b>
4.1	Power Connector .....	7
4.2	Communication Connector .....	7
4.3	Serial Communication Specifications .....	8
4.4	Dip Switch Assignment .....	9
4.5	Using Type of Cash Cassettes .....	10

	<b>DOC NO</b>	<b>MODEL</b>	<b>NAME</b>	<b>REV.</b>	<b>PAGE</b>
	PL-ECDM-400-02	ECDM-400	Product Specification	1.0	4 of 11

## 1 Preview and Features

### 1.1 Preview

ECDM-400 is the cash-dispensing unit that can be applied to ATM and notes exchanger for retail market. The main function is to dispense the exact number of banknotes in the cassette by a customer's request and to transfer to the customer automatically.

### 1.2 Features

- 1) To separate notes by friction rollers
- 2) To prevent from double dispensing case by mechanical double detect mechanism
- 3) To implement mold guides and paths to minimize jam occurrence
- 4) To maximize convenience in maintenance or clearing by opening guide structure
- 5) To realize compact and slim size so as to be applied to even small space
- 6) To speed at a rate of 4 notes/sec
- 7) After power failure, bills on the path are rejected to reject tray when power turns on again (Auto Reject Function)
- 8) To have lockable cassettes (up to 4 denomination) and a lockable reject box
- 9) To be able to set the banknote type of each cassette by setting Dip Switches of each cash cassette (refer to Ch. 4.5)

	<b>DOC NO</b>	<b>MODEL</b>	<b>NAME</b>	<b>REV.</b>	<b>PAGE</b>
	PL-ECDM-400-02	ECDM-400	Product Specification	1.0	5 of 11

## 2 Specifications

### 2.1 General Specifications

2.1.1	Denomination	4 Denomination
2.1.2	Cassette Capacity	214mm
2.1.3	Dispensing Speed	4 notes/sec
2.1.4	Usable Note Size	Width : 100 ~ 162mm Height: 62 ~ 78mm
2.1.5	Double Feeding Detection	Mechanical type
2.1.6	Reject Capacity	About 50 notes
2.1.7	Access Type	Front Access Type
2.1.8	Dimension (unit: mm)	270.5(W) x 618(H) x 420(D)
2.1.9	Interface	RS 232C
2.1.10	Near-end Detection (Selectable, Refer to Chapter 4.4 )	
	1) Near-end Disabled	All notes are dispensed until Bill-end.
	2) Near-end Enabled	50 or 150 notes* will be left and it stops.
	* The remaining amount will be decided to the position of Near-end sensor.	

### 2.2 Electrical Features

2.2.1	Rated Voltage	DC24V±10%
2.2.2	Rated Consuming Current	
	- Standby Status	0.2A
	- Average Current, continuous	7.5A
	- Average Current, peak	10.5A

### 2.3 Operation Environment

2.3.1	Operation Temperature	+ 5℃ ~ +40℃
2.3.2	Storage Temperature	-10℃ ~ +60℃
2.3.3	Operation Humidity	20% ~ 80% RH
2.3.4	Storage Humidity	10% ~ 90% RH

	DOC NO	MODEL	NAME	REV.	PAGE
	PL-ECDM-400-02	ECDM-400	Product Specification	1.0	6 of 11

### 3 Layout

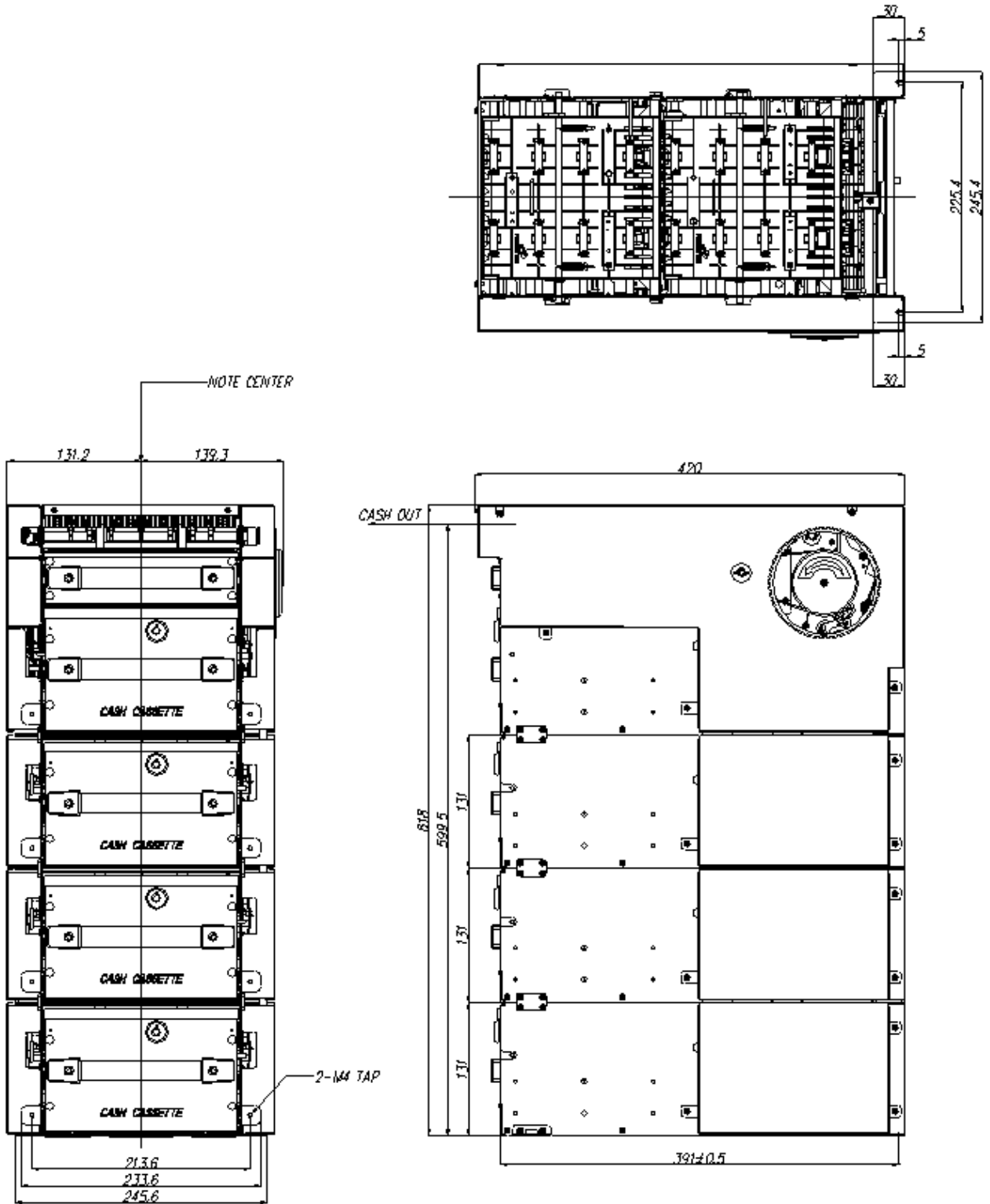

	<b>DOC NO</b>	<b>MODEL</b>	<b>NAME</b>	<b>REV.</b>	<b>PAGE</b>
	PL-ECDM-400-02	ECDM-400	Product Specification	1.0	7 of 11

## 4 Connector Specifications

### 4.1 Power Connector

The power connector is positioned at the bottom of the ECDM-400 main Controller.

Connector on Controller : MOLEX 5566VWO-02

Matching Connector : MOLEX 5557D-02

Pin No	Function
1	+24V
2	GND

### 4.2 Communication Connector

The communication connector is positioned at the bottom of the ECDM MAIN Controller PCB. It is 9-way and D-type connector.

Pin No	Name	Function
1		Not used
2	RXD	Received data
3	TXD	Transmitted data
4		Not used
5	GND	System ground
6		Not used
7		Not used
8		Not used
9		Not used

	<b>DOC NO</b>	<b>MODEL</b>	<b>NAME</b>	<b>REV.</b>	<b>PAGE</b>
	PL-ECDM-400-02	ECDM-400	Product Specification	1.0	8 of 11

### 4.3 Serial Communication Specifications

Baud rate	9600 bps
Data bits	8 bits
Parity	No parity
Stop bits	1 stop bit
Flow control	None



#### 4.4 Dip Switch Assignment

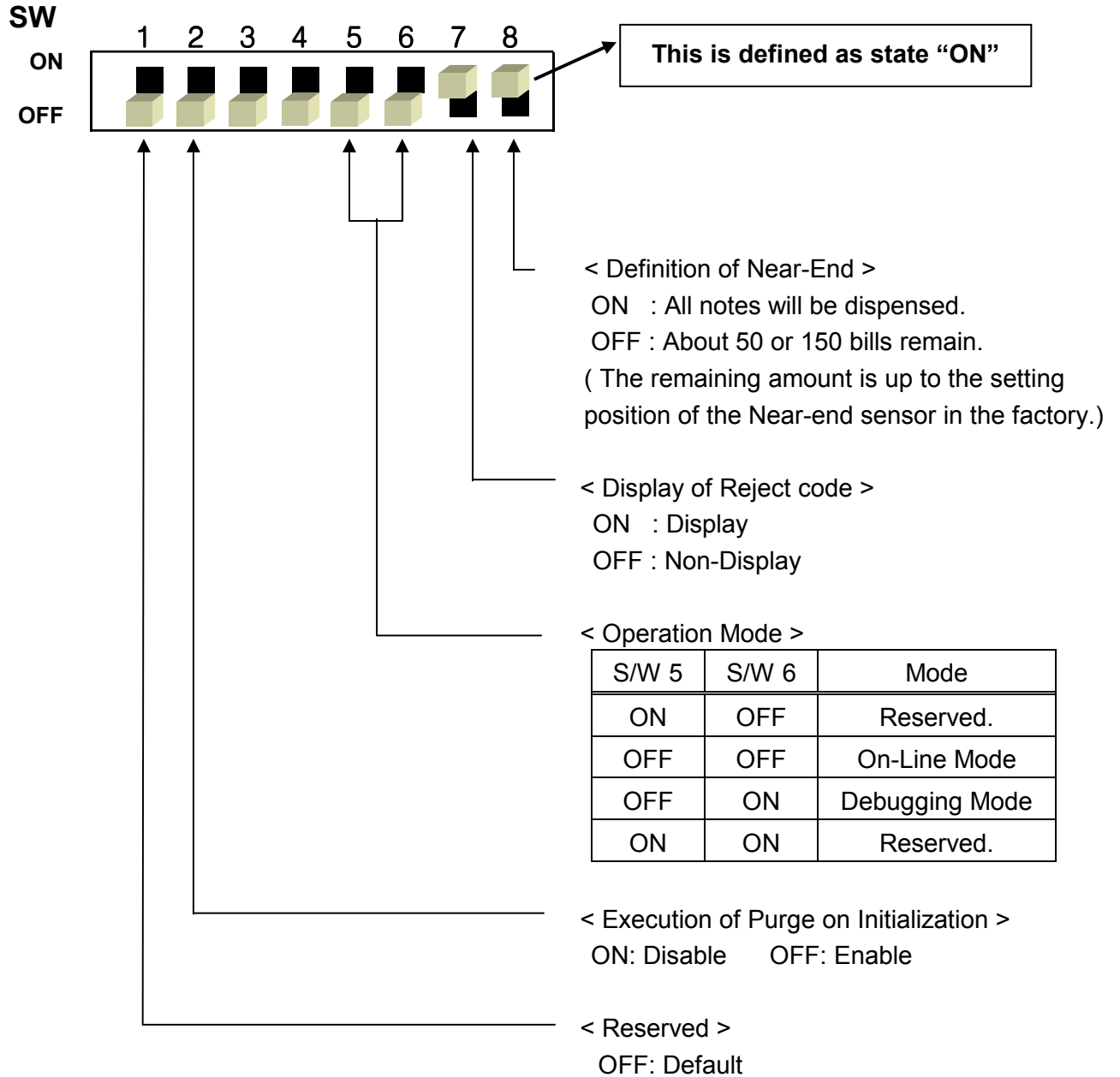

**CAUTION!**

Please turn on power again after changing the Dip Switch.

	<b>DOC NO</b>	<b>MODEL</b>	<b>NAME</b>	<b>REV.</b>	<b>PAGE</b>
	PL-ECDM-400-02	ECDM-400	Product Specification	1.0	10 of 11

#### 4.5 Using Type of Cash Cassettes

In case the Cash Cassettes with the same types exist in one ECDM-400 and at the same time one of the Cash Cassettes of the type has become no bill status, the banknotes of the other Cash Cassette with the same type will be automatically dispensed to complete the request of dispensing of banknotes. However, if a user sets different type to individual Cash Cassette, the sequential dispensing function is not active. The default type of the Cash Cassettes and the main body are set to 1, 2, 3 and 4 from the top to the bottom.

If the type of main body and the Cash Cassette are not matched, the unit shows the error message. A user can check or newly set the assigned type of main body through test program or command. Also the type of Cash Cassette can be set by the Dip Switches on the upper are of each cassette. Please refer to the following configurations for better understanding.

Default Type	Main Body Type	Cassette Type
Top Cassette	1	1
The 2 <sup>nd</sup> Cassette	2	2
The 3 <sup>rd</sup> Cassette	3	3
Bottom Cassette	4	4
How to Check or Change Type	Test Program or Command	Dip Switch Setting or Cassette Label

To change the type of the Cash Cassette, a user has to change the Dip Switch of the upper side of the Cash Cassette like the picture. Each type should be defined as the configuration of the picture. (When it is delivered to a customer, each Cash Cassette has been set to type 1,2,3 and 4 to its order from the most upper Cash Cassette.)

	DOC NO	MODEL	NAME	REV.	PAGE
	PL-ECDM-400-02	ECDM-400	Product Specification	1.0	11 of 11

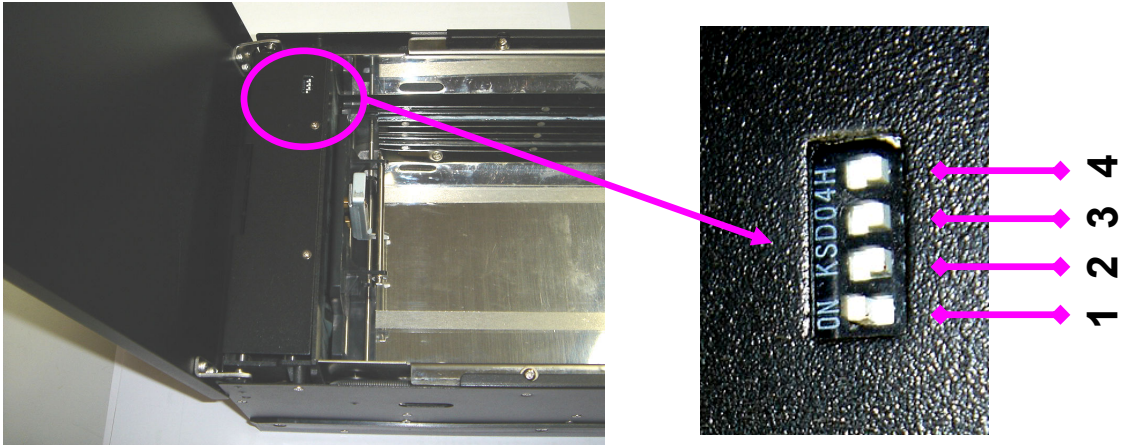

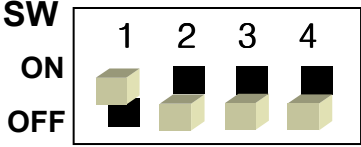
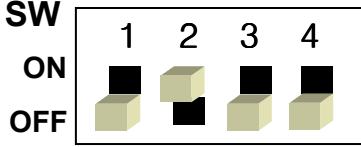
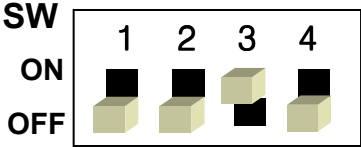
<p># TYPE 1 – SW1 ON</p> 	<p># TYPE 2 – SW2 ON</p> 
<p># TYPE 3 – SW3 ON</p> 	<p># TYPE 4 – SW4 ON</p> 